



**kerlite<sup>®</sup>**

Technical manual

**COTTO D'ESTE**  
Nuove Superfici



# THE NEW SURFACE FOR ARCHITECTURE

Kerlite is the laminated porcelain stoneware product by Cotto d'Este that is reinforced with fibreglass and whose strengths are its resistance, versatility, and ease of use. Light weight, flat, flexible, easy to cut, drill and lay, and easy to clean. The result of research focused on beauty and technical excellence, cardinal elements of modern architecture, Kerlite is a truly universal surface, ideal for various uses and applications: not just floor and wall covering, but also furniture, accessories, ventilated walls, and cladding of tunnels and major structures.

# kerlite®

## THE ADVANTAGES OF BEING UNIQUE

### THIN AND LIGHT

Slabs of Kerlite are particularly thin and have a weight of only 7,8 kg/m<sup>2</sup> for Kerlite 3plus (3,5 mm thick).

### LARGE

A range of slabs with sizes up to 3 x 1 metres. The perfection of the slabs allows for installation with narrow joints.

### FLAT

The innovative production process of Kerlite, which is pressed on a continuous belt, produces perfectly flat slabs.

### EASY TO CLEAN

Kerlite is non-absorbent, easy to clean and resists acid, stains and pollution.

### EASY TO INSTALL

Thin and light, easy to cut and drill, with Kerlite it is possible to save up to 40% on installation costs.

### RESISTANT

Laminated porcelain stoneware reinforced with fibreglass, perfectly compact and pressed with a force of 15,000 tons.

### ECOFRIENDLY

An environmentally friendly manufacturing process: 65% less consumption of raw materials, 80% less water required, 30% less energy required, 30% less CO<sub>2</sub> emissions.

### ANTIBACTERIAL

The PROTECT antibacterial protection active 24/7 eliminates up to 99.9% of all bacteria. Available in the main collections.

### GUARANTEED

The beauty and extraordinary quality of our floors are values that resist time: resistance of surfaces to wear and frost is guaranteed for 20 years.

**COTTO D'ESTE**  
N u o v e S u p e r f i c i

---

# COTTO D'ESTE

N u o v e S u p e r f i c i

The information in this Technical Manual relating to the product is to be intended as official information provided by Cotto d'Este.  
As far as ancillary materials (adhesives, mats, etc.) are concerned, the indications provided are those of the relative manufacturers, that guarantee the technical characteristics of their products on the market.







# Contents

<b>01</b>	<b>KERLITE</b>	<b>4</b>
1.1 -	What is KERLITE?	4
1.2 -	Available types: KERLITE 3mm, KERLITE 3plus and KERLITE 5plus	4
1.3 -	KERLITE 3plus and KERLITE 5plus: flexibility	4
<b>02</b>	<b>KERLITE 3mm, KERLITE 3plus and KERLITE 5plus: Which and Why?</b>	<b>5</b>
<b>03</b>	<b>Working with KERLITE 3mm, KERLITE 3plus and KERLITE 5plus</b>	<b>6</b>
3.1 -	Handling	6
3.2 -	Cutting, drilling and edge finishing	8
3.2.1 -	Manual processing	8
3.2.2 -	Machine processing	10
<b>04</b>	<b>Installing KERLITE 3mm, KERLITE 3plus and KERLITE 5plus</b>	<b>12</b>
4.1 -	The Substrate	12
4.1.1 -	Substrate: technical requirements	12
4.1.2 -	Substrate: special instructions for installation on pre-existing walls/floors	13
4.1.3 -	Substrate: special instructions for installation on exterior plaster walls	13
4.1.4 -	Substrate: instructions for self-supporting panels	14
4.1.5 -	Substrate: instructions for installation on mats used for uncoupling, soundproofing etc.	14
4.1.6 -	Substrate: instructions for special construction systems	16
4.1.7 -	Substrate: instructions for installing in accordance to "best practice"	17
4.2 -	Recommended adhesives	18
4.3 -	Instructions for installation	20
4.3.1 -	Adhesives: substrate troweling method / substrate and tile troweling method	20
4.3.2 -	Installing 300x100 cm slabs	20
4.3.3 -	Installation on curved surfaces	20
4.3.4 -	Grouting joints and expansion joints	21
<b>05</b>	<b>Cleaning and care</b>	<b>22</b>
<b>06</b>	<b>Connecting profiles, finishing and trim pieces</b>	<b>24</b>
<b>07</b>	<b>Making corners during installation</b>	<b>26</b>
7.1 -	Solution 1	26
7.2 -	Solution 2	27
<b>08</b>	<b>Technical information</b>	<b>28</b>
8.1 -	Technical features	28
8.2 -	Information for tender specifications	29
<b>09</b>	<b>Useful contacts</b>	<b>30</b>
	<b>Adhesives attachment</b>	<b>32</b>

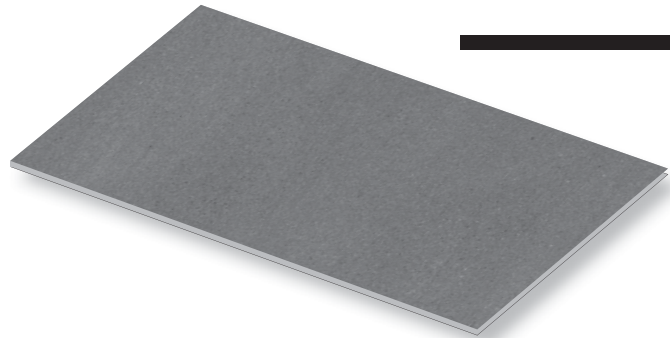
## 1.1 - What is KERLITE?

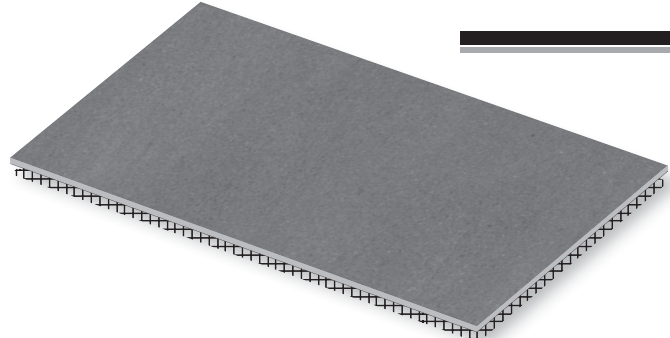
Produced by means of extremely innovative technology, KERLITE is manufactured in 300x100 cm slabs, using a porcelain stoneware body made of top quality raw materials. It is pressed at a force of 15,000 tons. Firing takes place in innovative and eco-friendly kilns that are the result of the research and know-how of Panariagroup. The ceramic KERLITE slabs are only 3 mm or 5 mm thick. This makes them flexible, light and extremely easy to handle. The minimal thickness is **the striking feature**, which makes the product suitable for a variety of different applications.

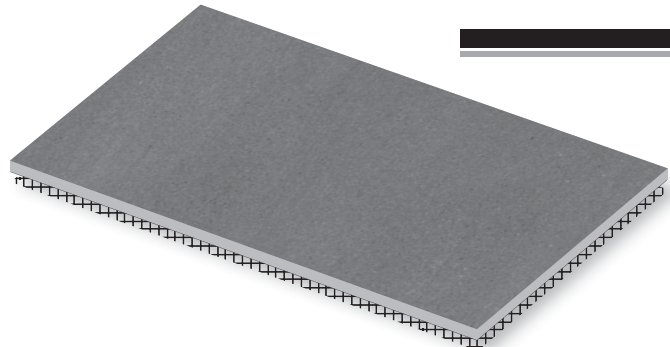
## 1.2 - Available types: KERLITE 3mm, KERLITE 3plus and KERLITE 5plus

	 <p><b>3 mm</b> thickness</p>	<h3>KERLITE 3mm</h3> <p>Porcelain stoneware slabs with a thickness of 3 mm, in sizes up to 300x100 cm.</p>
	 <p><b>3.5 mm</b> thickness</p>	<h3>KERLITE 3plus</h3> <p><b>With fibreglass mesh reinforcement</b> Porcelain stoneware slabs with a thickness of 3,5 mm, with fibreglass mesh on the rear side, in sizes up to 300x100 cm.</p>
	 <p><b>5.5 mm</b> thickness</p>	<h3>KERLITE 5plus</h3> <p><b>With fibreglass mesh reinforcement</b> Porcelain stoneware slabs with a thickness of 5,5 mm, with fibreglass mesh on the rear side, in sizes up to 300x100 cm.</p>

## 1.3 - KERLITE 3plus and KERLITE 5plus: flexibility

KERLITE 3plus and KERLITE 5plus feature high levels of flexibility.

Thanks to the quality of the raw materials, innovative production process, and the use of reinforced fibreglass, these products are able to adapt to curved, concave and convex surfaces.

The minimum radius of curvature is approximately 500 cm for KERLITE 3plus and 600 cm for KERLITE 5plus, in all the available formats.

Products with particular finishes can have certain limitations, so please contact the Panariagroup Research Centre before proceeding with the installation.











Min concave R.  
3plus = 500 cm  
5plus = 600 cm



Min convex R.  
3plus = 500 cm  
5plus = 600 cm



## KERLITE 3mm, KERLITE 3plus and KERLITE 5plus: Which and Why?\*

	<b>WALL INSTALLATION</b> For NEW BUILDINGS and RENOVATION projects that require installation on pre-existing wall cladding	KERLITE 3mm	KERLITE 3plus	KERLITE 5plus
 <b>Interiors</b>	Any residential and commercial environment, in situations where holes and/or cuts are <b>not</b> necessary.	●	●	●
	Any residential and commercial environment, in situations where holes and/or cuts are necessary.	-	●	●
 <b>Exteriors</b>	In situations where holes and/or cuts are <b>not</b> necessary and with sizes up to 100x100 cm.	●	●	●
	In situations where holes and/or cuts are necessary and/or for large sizes.	-	●	●
	<b>FLOOR INSTALLATION</b> For NEW BUILDINGS and RENOVATION projects that require installation on pre-existing floor coverings	KERLITE 3mm	KERLITE 3plus	KERLITE 5plus
 <b>Interiors</b>	<b>Residential</b> (kitchens, bathrooms, living rooms, common apartment block areas and any other residential environment).	-	●	●
	<b>Light commercial</b> (offices, offices open to the general public, waiting rooms, shops, bathrooms, restaurant dining rooms, car showrooms, bars, cinemas, surgeries/clinics).	-	●	●
	<b>Intensive commercial</b> (common areas of shopping centres, hotel foyers, canteens, fast food restaurants, dance clubs, hospitals) with the exception of areas subject to heavy concentrated loads (e.g. trolleys with hard wheels).	-	-	●
 <b>Exteriors</b>	Upon condition that surfaces are sheltered (e.g. loggias, covered balconies, etc.) and made totally impervious. We recommend the use of sizes that have sides not exceeding 100 cm.	-	●	●
SPECIAL USES		KERLITE 3mm	KERLITE 3plus	KERLITE 5plus
 <b>Ventilated façades</b>	Depending on project specifications and in combination with the construction systems recommended by Panariagroup and approved by the Project Supervisor.	-	●	●
 <b>External wall thermal insulation system</b>		● (◆)	●	●
 <b>Bathtubs and swimming pool cladding</b>		-	●	●
 <b>For furniture surfaces</b>		●	●	●

(\*) Products with special finishes can have limitations depending on their area of application. Refer to specific collection catalogues.

(◆) In situations where holes and/or cuts are not necessary and with sizes up to 100x100 cm.

## Working with KERLITE 3mm, KERLITE 3plus and KERLITE 5plus

### 3.1 - Handling

Owing to their lightness, all types of KERLITE slabs are much easier to handle and transport than marble, granite and natural stone slabs, which are much thicker and therefore much heavier. With an identical weight, the number of square metres transported is four times greater. The weight of a 100x100 cm slab is approximately 7.4 kg for the KERLITE 3mm, 7.8 kg for KERLITE 3plus and 11.5 kg for KERLITE 5plus. When handling, the use of gloves is recommended.

#### HANDLING WHOLE SLABS (300x100 cm) KERLITE 3mm, KERLITE 3plus AND KERLITE 5plus



**Fig.1** - All types of 300x100 cm KERLITE slabs can be lifted by one person. Lift the slab with open hands. Slowly raise the longer side so as to eliminate the suction effect, due to contact with the underlying slab, and ensure a good grip.

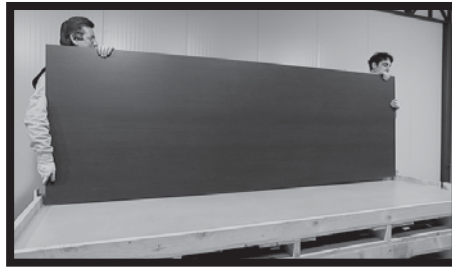

**Fig.2** - Guide the slab to its upright position, keeping it as straight as possible.



**Fig.3** - When the slab is upright, hold it from its top edge and shift it keeping it straight and upright. This operation should be performed with the aid of a second person.



**Fig.4/5** - All versions of KERLITE slabs, of size 300x100 cm, can be handled by two persons, using a special frame. Fix the frame to the slab when it is still on the pallet using the suction cups. Raise the frame and slab to eliminate the suction effect.



Owing to their lightness, all types of KERLITE are much easier to handle and transport than marble, granite and natural stone slabs, which are much thicker and therefore much heavier.

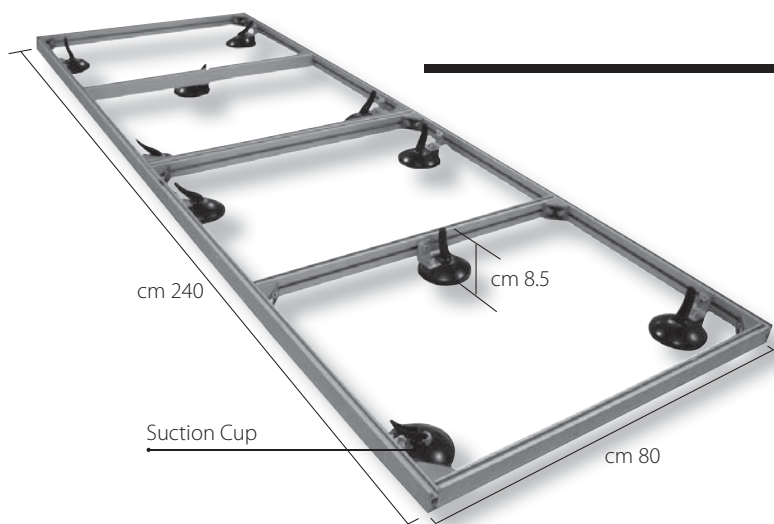

### The Frame

To safely handle and install KERLITE slabs, of various types in the 300x100 cm size, a special frame is available upon request. It is made of aluminium and features suction cups. It is ideal for installing on scaffolding at a height of over 2 metres.



### STORAGE OF WHOLE SLABS (300x100 cm)

All versions of KERLITE slabs (300x100 cm) can be stored either in vertical or horizontal position. If placing one slab on top of the other, make sure that each slab is clean and that the surface the slabs are resting on is flat.

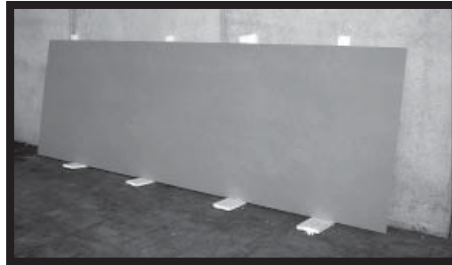

**Fig.6** - For upright storage, place the long side of the slab on wooden planks.

### HANDLING OF PACKAGES CONTAINING 300x100 cm SLABS

Lifting and handling palletised packages with forklift trucks:

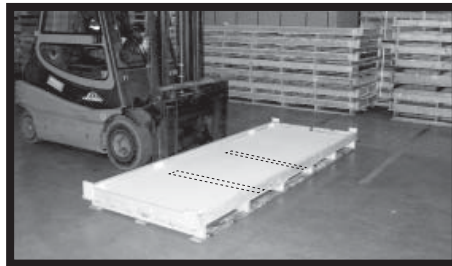

**Fig.7** - To take on pallets from their long side, position the forks at a distance of at least 1 metre apart, perpendicular to the long side of the pallet and at the centre of the latter. Forks must be supporting the entire depth of the pallet.



**Fig.8** - To take on pallets from their short side (e.g. when unloading containers), use forks with a length of at least 2,5 metres to guarantee a sufficiently long supporting surface and to protect the package and its contents.

## 3.2 - Cutting, drilling and edge finishing

A striking feature of KERLITE is its extreme ease-of-installation: this material can be easily cut, shaped and drilled both by tile layers and artisans (stone cutters, glass-workers, etc.) using automatic machines and tools for porcelain stoneware, glass and marble. For manual operations and when using mechanical tools (such as angle grinders, drills, cutters and electric screwdrivers drills), it is recommended to wear gloves, dust masks and protective eyewear. Follow the indications regarding the personal protective equipment that should be used provided by the manufacturers of the work tools.

If it is necessary to drill holes for pipes or perform cuts for switch boxes or other items, KERLITE 3plus or KERLITE 5plus must be chosen.



**A striking feature of KERLITE is its extreme ease-of-installation.**

### 3.2.1 - Manual processing

#### PREPARATION

It is essential to work on a flat and clean surface; it is possible to use the cover of the pallet of the 300x100 cm slabs.

#### CUTTING WITH A GLASS CUTTER OR MANUAL TILE CUTTER

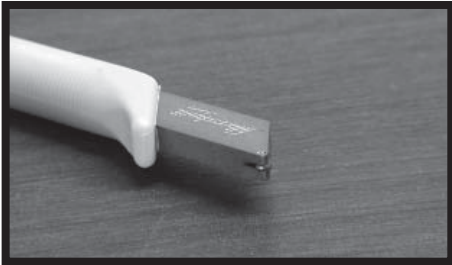

**Fig.9** - It is possible to obtain excellent results in terms of clean shapes and cuts by scoring all versions of KERLITE with products like Silberschnitt 2000 special glass cutters made by **Bohle Italia** or manual tile cutters made by **Würth**. For optimal results do not detach the glass cutter from the tile during the entire scoring operation. To cut polished surfaces use a tile cutter ruler (for instance Keracut by **Sigma** or Free-cut by **Raimondi**), exerting a strong pressure on the carriage mounted on the ruler (see **Fig.13**), or a diamond disc for porcelain stoneware (see **Fig.15**). To cut structured surfaces it is necessary to use a diamond disc for porcelain stoneware (see **Fig.15**).



**Fig.10** - So as to score the tile in a straight line, one can use aluminium straight edges normally used by builders.

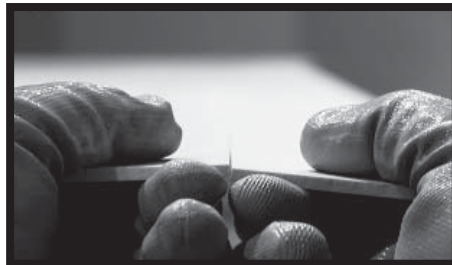

**Fig.11** - After scoring, it is sufficient to bend the slab to split the two pieces.



**Fig.12** - For KERLITE 3plus and KERLITE 5plus, after scoring the ceramic part and splitting the slab, complete the operation by cutting the fibreglass mesh with a standard cutter.

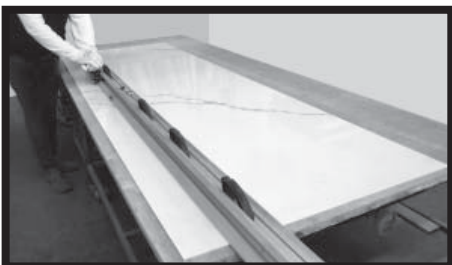

**Fig.13** - A practical tool for cutting is the tile cutter ruler (for instance Keracut by **Sigma** or Free-cut by **Raimondi**). For KERLITE 3plus and KERLITE 5plus, after scoring the ceramic part and splitting the slab, complete the operation by cutting the fibreglass mesh with a standard cutter (see **Fig.12**). It is advisable to use this tool to cut polished surfaces, exerting a strong pressure on the carriage mounted on the ruler. To cut structured surfaces it is necessary to use a diamond disc for porcelain stoneware (see **Fig.15**).

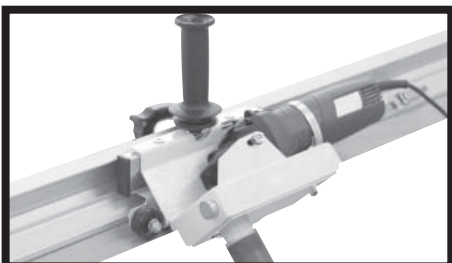

**Fig.14** - With tile cutter rulers, one can use hand-held angle grinders, fitted into special frames that can be "fit onto" the cutting guide (such as Free-flex 35°/55° by **Raimondi**). In this way it is possible to produce 90° cuts and 45° cuts for bevels and jolly pieces.

## CUTTING WITH DIAMOND DISCS



**fig.15** - All KERLITE versions can be cut using diamond discs fitted onto hand-held electrical grinding machines. Disc rotation speed must be high (> 10000 RPM) and feed rate low (< 1 m/min). Depending on the type of disc and the length of the cut, it may be necessary to cool the disc with water. Recommended discs are the thin types generally used for cutting porcelain stoneware. The advantages of this type of cut include ease-of-execution and the possibility to cut during installation.

## DRILLING

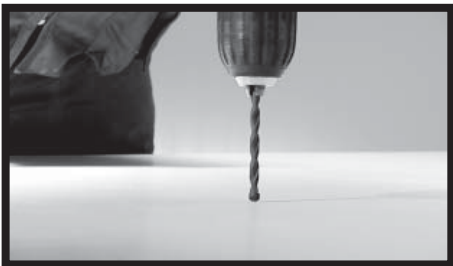

**Fig.16** - As far as manual drilling is concerned, use tungsten bits with a diameter up to 10 mm, fitted to electric drills or battery-operated screwdrivers.



**Fig.17/18** - As an alternative, one can use holesaws fitted to angle grinders, electrical drills or battery-operated screwdrivers.



## INTERNAL CUT / L-SHAPED CUT



**Fig.19** - To obtain internal and L-shaped corners, round off the vertices of the internal corner using drill bits with a radius of at least 5 mm to reduce the risk of breakage. Then cut with diamond discs, taking care to stop moving the cutting tool forward when the previously drilled hole is reached.

To drill and cut using diamond discs, follow the instructions provided above.

### When using these tools:

- cool the point being drilled with water;
- do not exert too much pressure and bear in mind the resistance of the type of laminated porcelain stoneware being worked on;
- when using tungsten drill bits, start drilling at a low speed;
- when using drills or screwdrivers, do not select hammer mode.

## EDGE FINISHING



**Fig.20** - Edges can be finished by hand using abrasive diamond sponges or emery paper. By slightly sanding the side of the slab, one can obtain a slightly rounded-off edge and with repeated sanding one can obtain bevelled effect.



**Fig.21** - The same results can be obtained with sanding discs fitted onto hand-held angle grinders.



**Fig.22** - The use of the grinder together with particular trolleys allows the execution of flat chamfers with angles between 35° and 55° (with Jolly-angle type trolleys produced by **Sigma**) or round chamfers (with a Bull type trolley produced by **Raimondi**).



**If it is necessary to drill holes for pipes or perform cuts for switch boxes or other items, KERLITE 3plus or KERLITE 5plus must be chosen.**

Irrespective of the processing method adopted, the underlying surface must be perfectly flat to prevent vibration and movements of the slab that could lead to breakage or damage to the finish. It is recommended to use diamond tools for porcelain stoneware, in good working order.

If it is necessary to drill holes for pipes or perform cuts for switch boxes or other items, KERLITE 3plus or KERLITE 5plus must be chosen. To obtain internal corners and L-shaped cuts, round off the edge of the corner using bits with a radius of at least 5 mm that reduce the risk of breakage. It is recommended to perform a few tests before cutting so as to set up the machine in the best manner possible. Operating parameters provided in this guide are to be considered as **indicative** and must be tested and checked by the user depending on the material used and the operations to perform.

### SCORING



**Fig.23** - All types of KERLITE can be cut by scoring. This operation must be performed on a cutting bench and on the front face of the slab. As far as KERLITE 3plus and KERLITE 5plus are concerned, if this operation cannot be performed automatically on a cutting bench, the fibreglass mesh must be cut by hand with a cutter. Move the cutting tool forward at a speed of 10 m/min. and in any case at a speed suitable for the finish and colour of the slab with an average pressure of around 1.2 bar. For slabs with light colours, exert a pressure of about 1.5 bar.

### CUTTING WITH A DISC



**Fig.24** - All versions of KERLITE can be cut with diamond discs. Use discs made especially for porcelain stoneware and in good working condition.

Disc rotation speed must be high (> 2000 RPM) and feed rate low (from 0,5 to 1 m/min.) Depending on the type of disc and the length of the cut, it may be necessary to cool the disc with water.

Reduce disc rotation speed at the start and at the end of the cut.

### CUTTING WITH CNC MACHINES



**Fig.25** - All versions of KERLITE can be cut with CNC machines.

Cutter rotation speed ranging between 12000 and 18000 RPM, with a feed rate between 0.5 and 1 m/min.

### CUTTING WITH WATERJET MACHINES



**Fig.26** - All versions of KERLITE can be cut with waterjet cutting machines.

The feed rate of this operation should be between 2 and 3 m/min.

### DRILLING WITH A CNC MACHINE

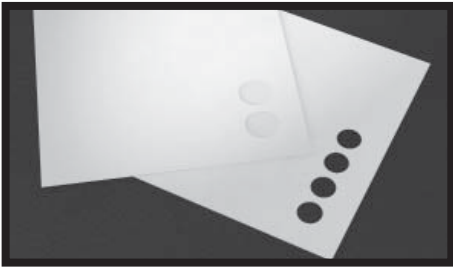

**Fig.27** - KERLITE, in all of its versions, can also be drilled using CNC machines. Drill a preliminary hole using a diamond drill bit and if necessary use a hole saw to enlarge the hole to the required dimensions. Use a drill bit with a diameter of between 4 and 8 mm. Operating speed is 40 mm/min. with spindle rotation of 900 RPM. When using these tools: cool the point drilled with water; start drilling at a low speed; never exert too much pressure and bear in mind the resistance of the type of KERLITE being worked on.

### DRILLING WITH A WATERJET MACHINE



**Fig.28** - All versions of KERLITE can be drilled with waterjet cutting machines. With waterjet machines, one can obtain holes with a smaller diameter compared to those possible with CNC machines. Operating speed must range from 2 to 3 m/min.

### EDGE POLISHING

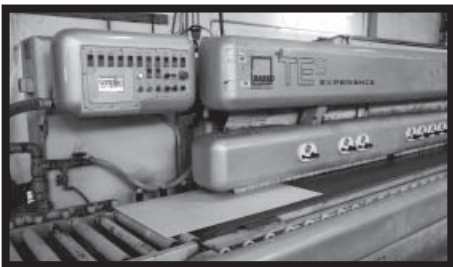

**Fig.29** - To shape and polish the edge of the slab, use diamond/abrasive discs, which are suitable for obtaining an edge of the shape and size requested. Finish the edge with a polishing disc. Different discs are available for obtaining different edge finishes. Operating speed must be tested beforehand.

### 45° CUT



**Fig.30** - To obtain 45° cuts, use 45° diamond discs. In this way, it is possible to join two slabs of KERLITE to create a corner. The corner must then be bevelled. Different discs are available for obtaining a variety of edge finishes. Operating speed must be tested beforehand.

### BEVELLING

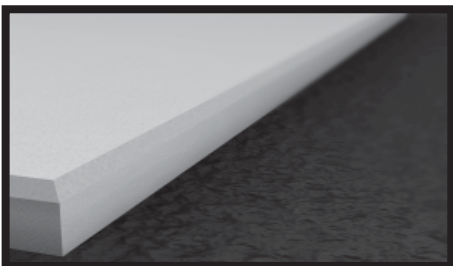

**Fig.31** - All versions of KERLITE can be bevelled. To smooth curved edges use a CNC machine with a 5 axis grinding wheel. Different discs are available for obtaining a variety of edge finishes. Operating speed must be tested beforehand.

## Installing KERLITE 3mm, KERLITE 3plus and KERLITE 5plus

As for all building materials, KERLITE works in combination with other materials. **For this reason, it is essential to:**

- define the characteristics of the substrate on which slabs will be installed (see "4.1 - **The Substrate**");
- choose an adhesive that is suitable for the substrate and intended use (see "4.2 - **Recommended adhesives**");
- lay KERLITE on the substrate in the correct manner (see "4.3 - **Instructions for installation**").

If the requirements of these three points are fulfilled, KERLITE will offer all the best of its unique characteristics.

### 4.1 - The Substrate

#### 4.1.1 - Substrate: technical requirements

Irrespective of whether one is installing on walls or on floors, the substrate **must** have the characteristics described in detail below. Testing and checking these conditions is the responsibility of the project designer and of the persons performing installation work.

##### ■ COMPACT

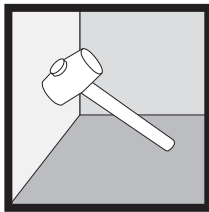
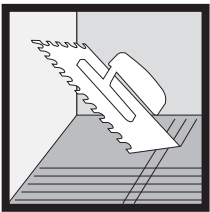

**Fig.32/33** - Make sure that the substrate is compact both in terms of surface and structure. Check compactness of surface by tracing (engraving) a grid on the substrate with the edge of a trowel or with a steel nail. A substrate can be considered as compact if it does **not** crumble or pulverise in the point where the lines of the grid intersect. Check compactness of the structure by tapping on the surface with a 750 g mallet: **no** marks should form and the sound heard when tapping must not be hollow. The presence of layers or areas with a more brittle consistence means that mechanical characteristics are poor and may cause breakage or dislodging of slabs.

##### ■ DRY

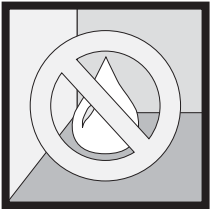

**Fig.34** - This test can be performed using a hygrometer for building materials. For cement-based screeds, a moisture content of less than 2% before installation is acceptable. As far as anhydrite screeds are concerned, the moisture content must be lower than 0,5%.

##### ■ FLAT

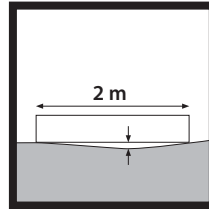

**Fig.35** - Flatness is checked by using a levelling rod with a length of at least 2 metres. Place the rod on the slab in all directions. The permissible tolerance is 2 mm.

##### ■ STABLE OVER TIME

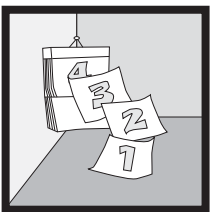

**Fig.36** - The substrate must have suitable features for the intended use and must remain stable over time.

##### ■ CLEAN



**Fig.37** - The substrate surface must be clean. Dust, oil, grease, dirt and debris must be removed as they may compromise adhesion.

##### ■ CRACK-FREE



**Fig.38** - In cement-based screeds, the presence of cracks due to hygrometric shrinkage is caused by one or more of the following factors: too much water in the mixture, too fine a grain size of the aggregates, too much cement. Before installation, fill any cracks and holes.

When installing on cement-based floors, the use of self-levelling products, such as **Mapei's** Ultraplan, guarantees all conditions described above. Use the product in accordance to the manufacturer's instructions.

## 4.1.2 - Substrate: special instructions for installation on pre-existing walls/floors

For installation on pre-existing walls / floors, apart from the features described in paragraph "4.1.1 - Substrate: technical requirements", also take into account the following indications:

### INSTALLATION ON HARDWOOD

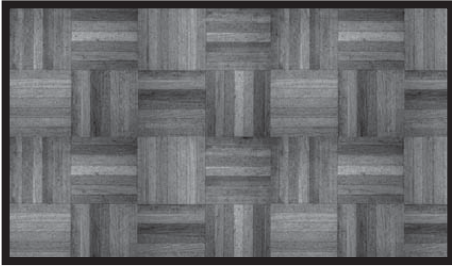

**Fig.39** - Make sure that the supporting material is sound and firmly fixed. Remove all residues of oil, paint, grease and wax by sandpapering the surface.

### INSTALLATION ON OLD CERAMIC TILES, COTTO, STONE, MARBLE, PVC

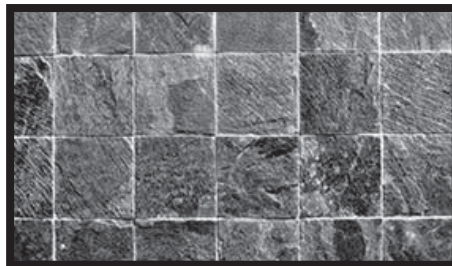
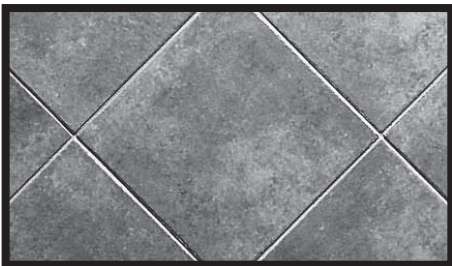

**Fig.40/41** - Make sure that the substrate is sound and firmly fixed. Eliminate any residues of oil, grease or wax by washing with a solution of water and caustic soda followed by thorough rinsing. If chemical cleaning is not possible, adopt mechanical abrasion techniques.

### INSTALLATION ON METAL

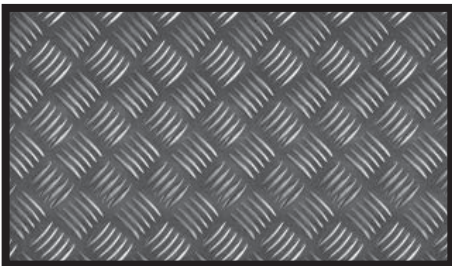

**Fig.42** - Make sure that the substrate material is sound and firmly fixed. All residues of oil, grease, wax and paint must be removed by means of mechanical abrasion systems. After cleaning, remove all residues with particular care.

## 4.1.3 - Substrate: special instructions for installation on exterior plaster walls

For installation on exterior plaster, apart from the features described in paragraph "4.1.1 - Substrate: technical requirements", also take into account the following indications:

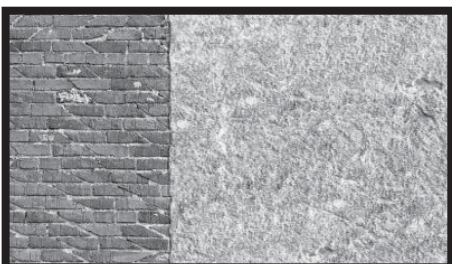

**Fig.43** - For wall installation on exterior plaster, KERLITE 3plus and KERLITE 5plus must be adhered onto a high performance substrate, which resists mechanical stress, such as structural movements, the weight of tiles, any thermal expansion and atmospheric agents. In this case, we recommend plaster such as KR100 from **Fassa Bortolo** or BF02 from **Grigolin**, or any plaster having the same characteristics with an average adhesion capacity to brick of at least 1 N/mm<sup>2</sup> (approx. 10 kg/cm<sup>2</sup>). In correspondence with the edges of doors, windows, etc., it is recommended to apply strips of mesh on the plaster, such as Mapegrid G 120 from **Mapei**, positioned at 45°. During installation, pay attention to stringcourses and structural joints.

#### 4.1.4 - Substrate: instructions for self-supporting panels

Direct installation on the following products has been tested for the conditions described below. For each of the following systems, follow the manufacturer's instructions and perform work in accordance to "best practice". After installing the system, make sure that the substrate on which the slabs will be laid has the features described in paragraph "4.1.1 - Substrate: technical requirements".



These self-supporting panels (such as for instance **Fig.44 - WEDI® building panels** and **Fig.45 - SCHLÜTER® - KERDI BOARD by Schlüter-Systems**) can be used:

- as supporting material for ceramic tiles;
- as substrate for installation of ceramic tiles;
- for protection against humidity;
- as effective heat insulating material;
- for design purposes.

The panels can be used in interior environments at normal temperatures.

For information about special uses (e.g. swimming pools, refrigerated rooms, exteriors, etc.), contact the manufacturer of the panel.



#### 4.1.5 - Substrate: instructions for installation on mats used for uncoupling, soundproofing etc.

Direct installation on the following products has been tested for the conditions described below. For each of the following systems, follow the manufacturer's instructions and perform work in accordance to "best practice". After installing the system, make sure that the support on which the slabs will be laid has the features described in paragraph "4.1.1 - Substrate: technical requirements".

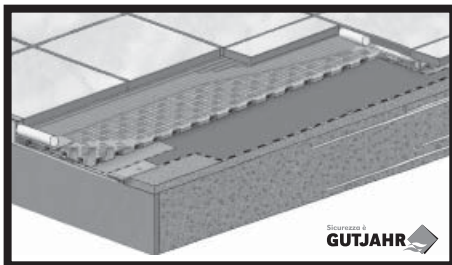
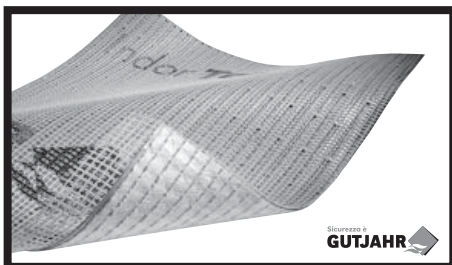

**Fig.46 - Watec® Drain Kp by Gutjahr®**

This is an uncoupling and draining cushioning material.

It is used:

- as drainage system for loggias, balconies and bathrooms;
- as uncoupling element in closed environments, such as: critical substrates (existing floors, different materials, etc.); screeds with a high content of calcium sulphate; heated floors; wooden substrates and dry screeds.



**Fig.47 - IndorTec® 2E-PZ by Gutjahr®**

This is a highly resistant uncoupling system with a reinforced mesh. This product must be adhered to the substrate. After it is possible to proceed with the tile installation. It is to be used in closed environments:

- critical substrates (existing floors, different materials, etc.);
- fresh, still damp cement screeds;
- heated floors;
- wooden substrates and dry screeds.



**Fig.48 - SCHLÜTER® - KERDI by Schlüter-Systems**

This material is a 0,2 mm thick polyethylene membrane, which is elastic and waterproofing. It is to be installed with adhesive under ceramic wall and floor tiles in bathrooms, showers, etc. The 0,5 mm version also acts as vapour barrier.



**ONLY FOR KERLITE 5plus**

Thanks to its physical and mechanical characteristics, KERLITE 5plus can also be used with different types of mats. Direct installation on the following products has been tested for the conditions described below. For each of the following systems, follow the manufacturer's instructions and perform work in accordance to "best practice". After installing the system, make sure that the support on which the slabs will be laid has the features described in paragraph "4.1.1 - **Substrate: technical requirements**".

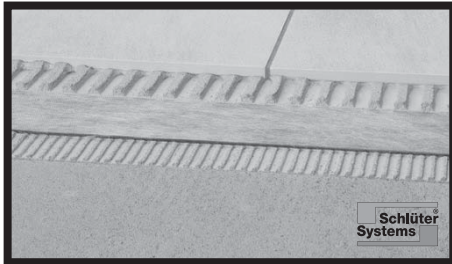
**Fig.49 - SCHLÜTER® - DITRA-SOUND by Schlüter-Systems**

This is an impact sound insulating mat, made of high density polyethylene, which is suitable for installation with adhesive under ceramic coverings. It has an anchoring fleece laminated on both sides to effectively bond with the tile adhesive.

**Fig.50 - SCHLÜTER® - DITRA 25 by Schlüter-Systems**

This is a polyethylene membrane for uncoupling, waterproofing and that allows release of pressure caused by vapour. Main applications:

- in interiors, for preventing cracks in floors, even when large slabs are used;
- on heated screeds for even diffusion of heat;
- as waterproofing system for loggias, covered balconies and bathrooms.

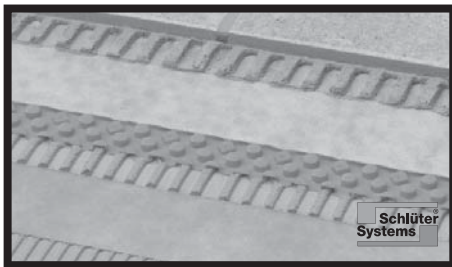
**Fig.51 - SCHLÜTER® - DITRA DRAIN 4 by Schlüter-Systems**

This material is a polyethylene membrane consisting of webbing and permeable fabric. It acts as a passive capillary drainage system and uncoupling system between the substrate and the ceramic floor. Main applications:

- in interiors, for preventing cracks in floors, even when large slabs are used;
- on heated screeds for even diffusion of heat;
- as integration for waterproofing system for loggias, balconies and bathrooms.

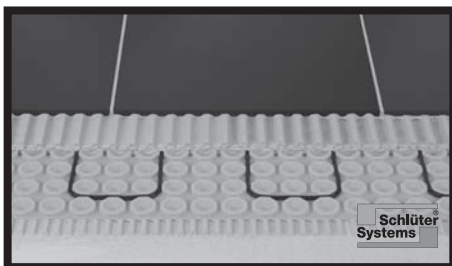
**Fig.52 - SCHLÜTER® - DITRA HEAT by Schlüter-Systems**

Schlüter®-DITRA-HEAT is an electric heating system for walls and floors with DITRA membrane technology: uncoupling, waterproofing, vapour pressure venting that guarantees intact coating over time.

The DITRA-HEAT-TB version with integrated heat shield can produce noticeable heat in very fast period of times.

- the areas to heat can be selected individually;
- the heating cable is laid in the membrane and embedded directly into the adhesive, so it is immediately below the ceramic surface;
- ideal for renovation projects thanks to its reduced height;
- system without self-levelling screed;
- easy and quick to install;
- it is used in interior spaces to guarantee crack free surfaces even when using large format tiles;
- certified system components.

**Fig.53 - Mapetex System by Mapei®**

This is a removable system, which preserves the integrity of the floor underneath.

The system consists of a special non-woven fabric (Mapetex), which is used in combination with adhesive strips (Mapetex-Strip) to create a support for the installation of floors that can be easily removed.

Mapetex can also be used as an isolating and anti-fracture membrane, limiting the damage that could be caused to the flooring by micro-cracks in the supporting element.

## 4.1.6 - Substrate: instructions for special construction systems

Installation is also possible on the following **construction systems** upon condition that these are installed in accordance to “best practice” and the manufacturer’s instructions and that the substrate has the characteristics described in paragraph “4.1.1 - **Substrate: technical requirements**”:

### INSTALLATION ON FIBRE CEMENT PANEL SYSTEMS (BACKER BOARD)

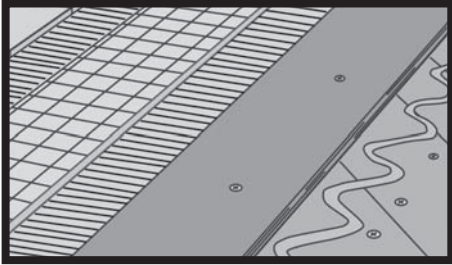

**Fig.54** - This system consists of cement-based panels enclosed within two layers of fibre-glass mesh, to be installed both on walls and on floors, fixed either mechanically or chemically to the underlying structure. When preparing this support, strictly follow the manufacturer’s instructions. Make sure that the points of contact between support and slab are filled with adhesive and that there is an overlying layer of fibreglass mesh submerged in the adhesive used for installation. This will ensure a support without cracks. After installing the system, make sure that the support on which the slabs will be laid has the features described in paragraph “4.1.1 - **Substrate: technical requirements**”.

### INSTALLATION ON SUSPENDED TIMBER FLOORS

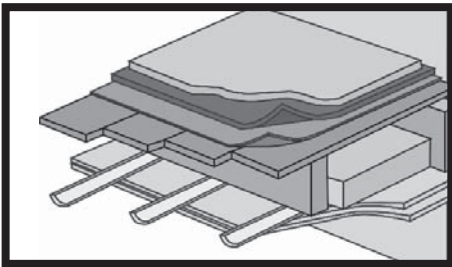

**Fig.55** - This construction system consists of a floor made of wooden planks secured by means of nails to a lattice of stringers. Installation of this construction system is similar to **installation on hardwood - Fig.39**: follow the instructions provided.

### INSTALLATION ON SUSPENDED SUPPORTS (E.G. GIFAFLOOR FHBPLUS BY KNAUF)

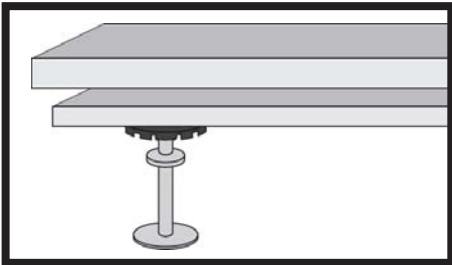

**Fig.56** - This system consists of gypsum fibreboard panels laid on steel supports with an adjustable height. When preparing this system, strictly follow the manufacturer’s instructions. Make sure that the points of contact between support and slab are filled with adhesive. This will guarantee a crack-free support. After installing the system, make sure that the support on which the slabs will be laid has the features described in paragraph “4.1.1 - **Substrate: technical requirements**”. Application of a primer before the tile adhesive must be decided upon by the manufacturer of the adhesive that will be used.

### INSTALLATION ON ELECTRICAL HEATING SYSTEMS

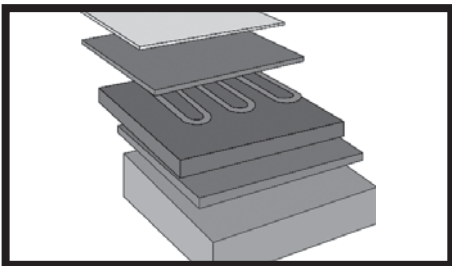

**Fig.57** - An evolution of the classical heating system where the radiant element is embedded in the screed. This system consists in installing the radiant element beneath the tiles or rather in the adhesive used for installation of KERLITE or under a layer of self-levelling mortar. This type of system can be installed directly on a screed or existing floor. A layer of insulating material may be installed in between. Irrespective of the number and type of layers, after the adhesive or self-levelling mortar has cured, it is important to check that the substrate has the features described in detail in paragraph “4.1.1 - **Substrate: technical requirements**”.

### WALL INSTALLATION ON UNCOUPLING AND MICROVENTILATED CUSHIONING - SYSTEM CeroVent® BY GUTJAHR®

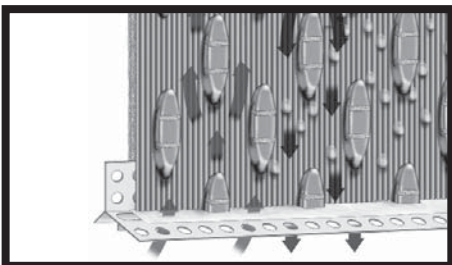
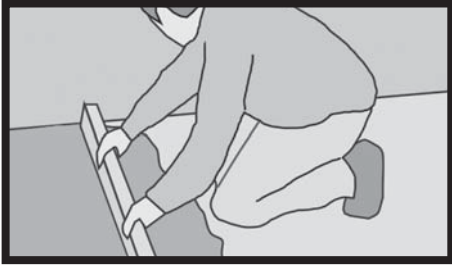

**Fig.58** - KERLITE 3plus and KERLITE 5plus can be installed directly on the **Gutjahr®** system **CeroVent®**. This system allows for wall installation (walls featuring salt and rising damp, damaged façades, mixed supports, prefabricated materials, etc.) and offers microventilation and uncoupling from the substrate.

## 4.1.7 - Substrate: instructions for installing in accordance to "best practice"

Hereunder we have listed some basic information concerning "best practice" to follow for the most common types of substrates:

### CEMENT-BASED SCREEDS

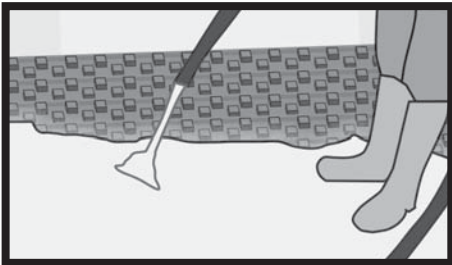

**Fig.59** - The curing time of cement-based screeds is of utmost importance. As far as conventional sand/cement screeds are concerned, this time is about 7/10 days per cm of thickness. If using premixed products, such as **Mapei's** Topcem Pronto or **Kerakoll's** Keracem Eco Pronto, follow the instructions of the manufacturer.

#### General rules for correct construction of a screed:

- aggregates: these must be clean and not contain impurities. The grain size must be suitable for the thickness of the screed to be made;
- levelling strips: these must be made using the same binding agent used for the screed;
- filling between hardened surfaces and moist mixture: joints between hardened screeds and moist mixture must be made by applying to the end of the hardened screed (clearly cut, perpendicular to the support) adhesion grout, water and binding agent;
- presence of pipes in the screed: the overlaying layer of mortar must be at least 2.5 cm thick; it is necessary to place, above the pipes, a metal mesh with a wire thickness of 2 mm so as to provide the necessary reinforcement beneath the thin layer of screed above and prevent the formation of cracks;
- finish: finishing can be performed with a trowel, a steel disc or smoothing tool, paying attention neither to moisten the surface too much nor to work for too long on the same area;
- checking residual moisture: this must be performed after the screed has reached the end of its curing period.

### ANHYDRITE SLABS



**Fig.60** - Follow the instructions of the manufacturer. Before installation, the screed must be sandpapered, dedusted and perfectly dry (the maximum permissible moisture content is 0,5%).

### HEATED SCREEDS

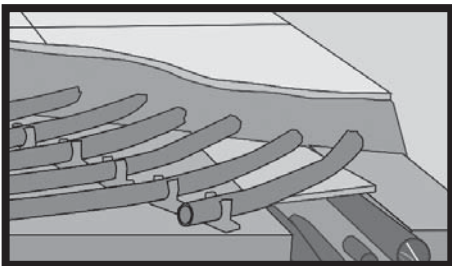

**Fig.61** - Before starting the heating floor system, wait at least 14 days after casting the screed. As prescribed by the UNI EN 1264-4 standard, in point 4.4, heating begins at an initial temperature ranging from 20°C to 25°C, which must be maintained for at least 3 days. Then set the maximum permissible design temperature and maintain it for at least 4 days. Once the floor has reached ambient temperature, tile installation can begin.

### CONCRETE

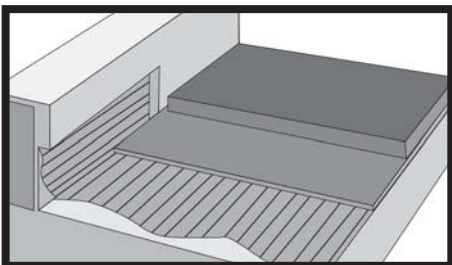

**Fig.62** - Concrete must be sufficiently cured (this takes about 6 months or even more, depending on its thickness, composition, thermo-hygrometric requirements, etc.) and must not feature surface treatments such as mould release agents, resin, anti-evaporation treatments, old adhesives, etc. Floor slabs must be insulated against rising damp.







## 4.2 - Recommended adhesives

As a general rule that applies for all building materials to be fixed in place with adhesive, there is no universal adhesive for installing KERLITE on all kinds of surface. Since it is not possible to describe all possible cases, we have provided information about the most common situations. First of all, we have divided installation cases into "walls" and "floors" and then into "interior" and "exterior". Depending on the hypothetical stress, on any work to be performed subsequently and on the maximum dimension of the slab, we have assigned a certain type of KERLITE to each category. Starting from this classification, we have thus examined the most common kinds of supporting material. The resulting chart has been sent to all main manufacturers of adhesives that have, in turn, provided the most suitable product for each category.

Please note that all solutions suggested have been submitted by adhesive manufacturers, who guarantee the indications given.

For explanations or more information, contact the product manufacturers (see "9 - Useful contacts").

**It is essential to follow all instructions given by adhesive manufacturers. This applies in particular to waiting times before a surface is "set for light foot traffic", "ready for grouting" and "ready to use" that are indicated in the following tables.**

 <b>WALL INSTALLATION(*)</b> For NEW BUILDINGS and RENOVATION projects that require installation on pre-existing wall cladding					
 <b>Interiors</b>	Any residential and commercial environment, in situations where holes and/or cuts are <b>not</b> necessary.	KERLITE 3mm	Two-coat plaster, gypsum plaster, plasterboard, fibre cement panels	<b>Pag. 34</b>	
			Concrete, old ceramic tiles, marble, stone	<b>Pag. 35</b>	
			Particle board, metal	<b>Pag. 36</b>	
	Any residential and commercial environment, in situations where holes and/or cuts are necessary.	KERLITE 3plus KERLITE 5plus	Two-coat plaster, gypsum plaster, plasterboard, fibre cement panels	<b>Pag. 37</b>	
			Concrete, old ceramic tiles, marble, stone	<b>Pag. 38</b>	
			Particle board, metal	<b>Pag. 39</b>	
 <b>Exteriors</b>	In situations where holes and/or cuts are <b>not</b> necessary and with sizes up to 100x100 cm.	KERLITE 3mm	Plaster	<b>Pag. 40</b>	
			Concrete	<b>Pag. 41</b>	
	In situations where holes and/or cuts are necessary and/or for large sizes.	KERLITE 3plus KERLITE 5plus	Plaster	<b>Pag. 42</b>	
			Concrete	<b>Pag. 43</b>	
 <b>FLOOR INSTALLATION(*)</b> For NEW BUILDINGS and RENOVATION projects that require installation on pre-existing floor coverings					
 <b>Interiors</b>	Residential (kitchens, bathrooms, living rooms, common apartment block areas and any other residential environment).	KERLITE 3plus KERLITE 5plus	Cement-based screeds, calcium sulphate-based or heated screeds, self-levelling products, concrete, old ceramic tiles, marble slabs, stone	<b>Pag. 44</b>	
	Light commercial (offices, offices open to the general public, waiting rooms, shops, bathrooms, restaurant dining rooms, car showrooms, bars, cinemas, surgeries/clinics).		Hardwood, PVC, rubber, linoleum, metal, resin	<b>Pag. 45</b>	
	Intensive commercial (common areas of shopping centres, hotel foyers, canteens, fast food restaurants, dance clubs, hospitals) with the exception of areas subject to heavy concentrated loads (e.g. trolleys with hard wheels).	KERLITE 5plus	Cement-based screeds, calcium sulphate-based or heated screeds, self-levelling products, concrete, old ceramic tiles, marble slabs, stone	<b>Pag. 44</b>	
			Hardwood, PVC, rubber, linoleum, metal, resin	<b>Pag. 45</b>	
	 <b>Exteriors</b>	Upon condition that surfaces are sheltered (e.g. loggias, covered balconies, etc.) and made totally impervious. We recommend the use of sizes that have sides not exceeding 100 cm.	KERLITE 3plus KERLITE 5plus	Cement-based screeds, calcium sulphate-based or heated screeds, self-levelling products, concrete, old ceramic tiles, marble slabs, stone	<b>Pag. 44</b>
				Hardwood, PVC, rubber, linoleum, metal, resin	<b>Pag. 45</b>

(\*) Products with special finishes can have limitations depending on their area of application. Refer to specific collection catalogues.

## How to read the **attachment**

At the discretion of P.S.	Supplier	Size of slabs (cm)	Product (*) (****)	Primer, if necessary (*) (****)	Mixing ratio (**)	Class (*)	Nominal coverage (*)	Set for light foot traffic and ready for grouting times (***)	Ready for use (***)	Installation (*)
<b>01</b>	<b>02</b>	<b>03</b>	<b>04</b>	<b>05</b>	<b>06</b>	<b>07</b>	<b>08</b>	<b>09</b>	<b>10</b>	<b>11</b>

- 01**\_ The project supervisor must examine the conditions of the work site to choose between a normal setting adhesive or a quick setting.
- 02**\_ List of adhesive manufacturers.
- 03**\_ The size in cm of the slab is indicated according to the adhesive recommended by the manufacturer.
- 04**\_ List of adhesives recommended by manufacturers based on the intended use and size of slabs.
- 05**\_ List of primers to use before adhesive application, as indicated by manufacturers for each intended use.
- 06**\_ The mixing ratio refers to a single product unit (a bag, a can, etc.), in order to obtain the characteristics declared by manufacturers.
- 07**\_ The adhesive's class under the UNI EN 12004 standard is indicated (see Sheet below "About ADHESIVES").
- 08**\_ Indication of how many square metres one can install with a single product unit prepared with the indicated mixing ratio.
- 09**\_ Time that must pass before treading on the surface to fill joints with grout.
- 10**\_ Time that must pass before using the floor, i.e. before it can be subjected to static and/or dynamic loads.
- 11**\_ Installation method and features of the trowel to use for each adhesive.

### About ADHESIVES

**Adhesives are divided into THREE CLASSES, depending on their chemical composition, as established by the UNI EN 12004 standard:**

CEMENTITIOUS (**C**): mixture of hydraulic binding agents, aggregates and organic additives  
(N.B.: to be mixed with water or other liquid additive immediately before use)

REACTIVE (**R**): mixture of synthetic resin, mineral fillers and organic additives, which harden due to a chemical reaction  
(N.B.: these adhesives may have one or more components)

IN DISPERSION (**D**): mixture of binding and organic agents, namely polymers in aqueous dispersion, organic additives and mineral fillers  
(N.B.: ready-to-use mixtures)

**Depending on their features, adhesives are thus classified:**

Class **1**: normal setting adhesives

Class **2**: improved setting adhesives

**There are three optional classes:**

Class **F**: quick setting adhesives

Class **T**: slip resistant adhesives

Class **E**: adhesives with extended open time

**There is a fourth additional class for cementitious adhesives only: adhesives can be classified as DEFORMABLE (S) and divided on the basis of test results under the UNI EN 12002 standard:**

Class **S1**: deformable adhesives

Class **S2**: highly deformable adhesives

## 4.3 - Instructions for installation

### 4.3.1 - Adhesives: substrate troweling method / substrate and tile troweling method

The installation technique and type of trowel to use depend mainly on the type of adhesive used. This information can be found in the "4.2 - Recommended adhesives" section. Depending on the intended use and on the type of adhesive used, all versions of KERLITE can be installed both with substrate troweling of adhesive or with substrate and tile troweling of adhesive. In all cases, follow the indications below and make sure that substrate and slab are entirely covered with adhesive.

#### SUBSTRATE TROWELING METHOD

This method refers **only** to adhesives that bear the indication "substrate troweling" in the "4.2 - Recommended adhesives" section. Comb the adhesive over the whole surface to be covered, using a trowel with the features indicated in the "4.2 - Recommended adhesives" section.

#### SUBSTRATE AND TILE TROWELING METHOD



Fig.63

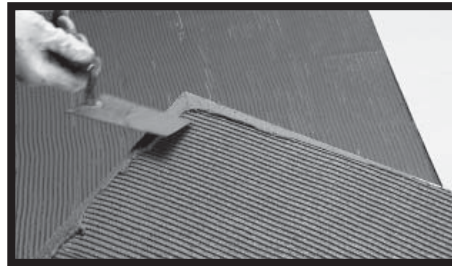

Fig.64

Apply adhesive on the substrate and on the back of the tile by combing the adhesive on the entire surface to be covered, using a notched trowel with tilted teeth that are spaced 6 mm apart (e.g. **Raimondi art.138HFV6**) and by combing the adhesive on the back side of the slab, using a trowel with 3 mm teeth (**Fig.63**). When installing on floors, remember to spread extra adhesive around the edge of the slab (**Fig.64**).

#### BOTH FOR "SUBSTRATE TROWELING" AND "SUBSTRATE AND TILE TROWELING" METHODS



Fig.65



Fig.66

After laying the slab, make sure it is firmly adhering to the underlying surface to prevent gaps and air bubbles forming. To do this, use rubber coated trowels (e.g. **Raimondi "142G" Fig.65**) for wall or for floor installation, or electrical tile tapping tools with plastic plates (e.g. **Raimondi "Cucciolo" Fig.66**) for floor installation.

### 4.3.2 - Installing 300x100 cm slabs

#### How to install 300x100 cm size slabs:

**Fig.67** - To handle slabs, raise them to their upright position, whilst grasping them from the top edge. They can then be moved with the help of a second person.

**Fig.68** - Rest the slab on its long side and guide it towards the floor.



### 4.3.3 - Installation on curved surfaces

**Fig. 69** - KERLITE 3plus and KERLITE 5plus can be laid on curved surfaces, both concave and convex. Products with particular finishes can have certain limitations depending on the geometry of the slab, so please contact the Panariagroup Research Centre before proceeding with the installation. The instructions for installation are those explained in chap. "4.3.1 - Adhesives: substrate troweling method / substrate and tile troweling method" and "4.3.4 - Grouting joints and expansion joints". We recommend installation using the substrate and tile troweling method, please refer to the adhesive manufacturer's instructions also with regard to any measures for securing the position of the slab during the curing times of the adhesive used (i.e. propping).

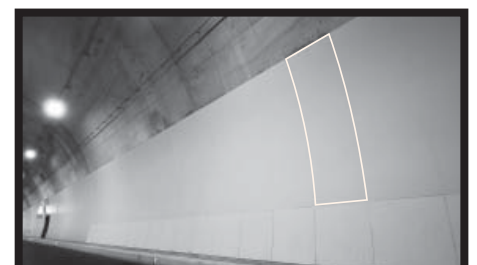

### 4.3.4 - Grouting joints and expansion joints

KERLITE has an expansion coefficient equal to  $7,0 \times 10^{-6} \text{ } ^\circ\text{C}^{-1}$  (e.g. for a temperature range of  $70^\circ\text{C}$ , expansion is 0,5 mm per linear metre). Despite expansion being minimal, it is **mandatory** to install all types of KERLITE, both for walls and floors, in compliance with the following instructions:



#### Wall installation

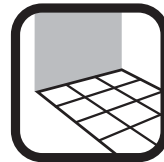

#### Floor installation

 <b>Interiors</b>	<b>Joint between slabs mandatory.</b> Minimum size at least 1 mm.	The size and position of the <b>expansion joints</b> must be established by the project supervisor.	 <b>Interiors</b>	<b>Joint between slabs mandatory.</b> Minimum size at least 2 mm.	<b>Expansion joints are mandatory.</b> The size and position of the joints must be established by the project supervisor. As a general rule, they should be positioned at least every 15/20 m <sup>2</sup> .
 <b>Exteriors</b>	<b>Joint between slabs mandatory.</b> Minimum size at least 5 mm.	<b>Expansion joints are mandatory.</b> The size and position of the joints must be established by the project supervisor. As a general rule, they should be positioned at least every 9 m <sup>2</sup> .	 <b>Exteriors</b>  <small>On condition that surfaces are sheltered (e.g. loggias, covered balconies, etc.) and made totally impervious. We recommend the use of sizes that have sides not exceeding 100 cm.</small>	<b>Joint between slabs mandatory.</b> Minimum size at least 5 mm.	<b>Expansion joints are mandatory.</b> The size and position of the joints must be established by the project supervisor. As a general rule, they should be positioned at least every 9 m <sup>2</sup> .

**FURTHERMORE:**

 <b>Interiors</b> Wall installation Floor installation	 <b>Exteriors</b> Wall installation Floor installation
---	---

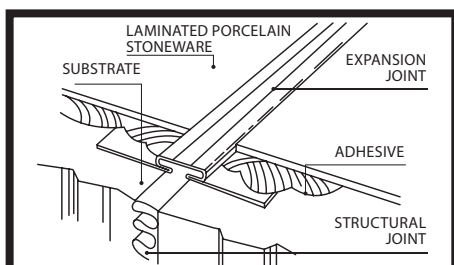

**Fig.70** - In correspondence with a structural joint in the screed, it is mandatory to install an expansion joint with a width that is at least the size of the existing one.

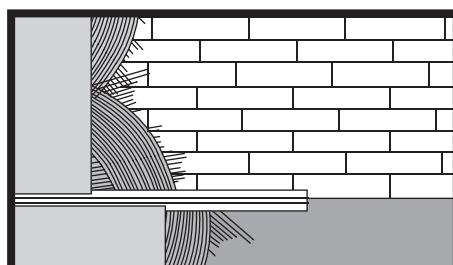

**Fig.71** - If there are joints between surfaces of different types (e.g. reinforced concrete and bricks), it is mandatory to install an expansion joint.

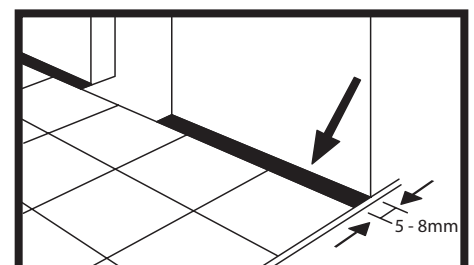

**Fig.72** - Around fixed elements of the supporting surface, such as walls, steps, columns, etc., it is mandatory to install 5-8 mm peripheral joints.

For suggestions on the type of joint to use, see "6 - Connecting profiles, finishing and trim pieces". Please also remember that expansion joints can be made using silicone products.

## Cleaning and care

### ■ "POST-INSTALLATION" CLEANING

"Post installation" cleaning helps remove residues of joint grouts, cement and lime. This operation is mandatory after installation both for glazed and unglazed tiles. Never clean tiles that are too hot (e.g. exposed to sunlight during hot summer months) since the reaction of aggressive chemicals may become harsher. In the summer, proceed with the operation during the coolest period of the day.

**Non-slip surfaces:** due to their particular, non-slip, rough or structured textures are more difficult to clean.

Therefore pay particular attention to cleaning methods, in particular clean sooner and use single disc cleaning machines with white and beige discs.

Grout used	When to clean	What to use	Instructions
<b>Cementitious grout mixed with water</b>	After 4/5 days and within 10 days from grouting	Acid-based detergents (see "List of acid-based detergents")	Follow the instructions supplied by the manufacturer of the detergent. Test the product on the tiles before use. This applies in particular to honed or polished products. Before cleaning, the surfaces must be dampened with water. After cleaning, dry up any remaining liquid (if possible using a wet vacuum cleaner) and rinse thoroughly and several times with water. Soak up any remaining rinsing water with a wet vacuum cleaner or a cloth.
<b>Epoxy grout, two-component and reactive</b>	Immediate	Follow the instructions of the grout manufacturer.	This type of product must be removed immediately and thoroughly since these grouts harden very rapidly, even in just a few minutes. Strictly follow the cleaning methods recommended by the grout manufacturer and check if it is effective by performing a cleaning test before grouting the entire floor/wall.

#### List of acid-based detergents



(\* Follow the instructions given on the package. Test the product on the tiles before use. This applies in particular to honed or polished products.

Name of detergent	Supplier
Keranet	Mapei
Cement Remover	Faberchimica
Deterdek	Fila
Trek	Kiter
Zementschleierentferner	Lithofin
HMK R63	HMK
Solvacid	Geal
Litoclean Plus	Litokol
Bonaclean / Bclean	Bonasystems Italia
Bonadecon (*) / Bdecon (*)	Bonasystems Italia

(\* for products that are not acid-resistant)

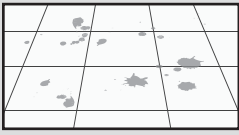

#### If post-installation cleaning has not been performed correctly

Grout used	What do you see?	What should you do?
<b>Cementitious grout mixed with water</b>	Residues, glossy stains. 	Repeat washing after installation as described above.
<b>Epoxy grout, two-component and reactive</b>	Grout haze, around the joints. 	Once it has hardened, grout is very difficult or even impossible to remove. Contact the grout manufacturer.

### ■ PROTECTIVE AGENTS FOR GROUTING JOINTS

These are used to reduce porosity and therefore make cement-based grouting more resistant to stains. Use of these protective agents can make cleaning easier. Follow the instructions given on the package. Test the product on the tiles before use. This applies in particular to honed or polished products.

Grout used	Product name	Supplier	Instructions
<b>Cementitious grout mixed with water</b>	Fugaproof KF Fugenschutz	Fila Lithofin	Follow the manufacturer's instructions

### ■ ANTISLIP TREATMENT

Non-slip properties of installed floors (glazed or unglazed) can be improved using specific products. Follow the instructions given on the package. Before applying the product make a precautionary test on a tile that is not laid in order to find the most suitable contact time. The longer the product is left acting on the tile, the more this increases the non-slip properties. However, this can whiten the tiles a little and make cleaning a little more difficult. Before doing any test please contact Bonasystems Italia company, since this is a very technical application.

Product name	Supplier	Instructions	Maintenance
<b>Bonagrip</b>	Bonasystems Italia	Follow the manufacturer's instructions	Bonamain / Bmain Follow the manufacturer's instructions



## ■ DAILY CLEANING

Use warm water and a good quality microfibre cloth, such as MAGIC CLEAN by **Bonasytems Italia**. Every now and again, e.g. every 10-20 days depending on the state of the flooring, use neutral detergents diluted with **a lot of** hot water, that are wax-free, and do not deposit glossy stains and dry with a good quality microfibre cloth. After washing, rinse thoroughly with water; dry using another good quality microfibre cloth, such as MAGIC CLEAN made by **Bonasytems Italia**.

Slab to be cleaned	What to use	Instructions
KERLITE 3mm KERLITE 3plus KERLITE 5plus DECORS	Wax-free neutral detergent (cf. "List of detergents"). DO NOT use alcohol, acids, solvents, abrasive detergents, steel wool or abrasive sponges.	As indicated above.

List of detergents	
<p>(*) Follow the instructions given on the package. Test the product on the tiles before use. This applies in particular to honed or polished products.</p>	
Name of detergent	Supplier
Floor Cleaner Fila Cleaner Pflegerreiniger HMK P15 Bonamain + (*) / Bmain + (*) Bonatitania Clean / Bitania Clean Belgres	Faberchimica Fila Lithofin HMK Bonasytems Italia Bonasytems Italia Geal
(*) NEVER use to clean decors	

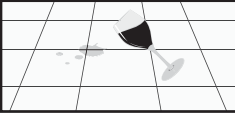
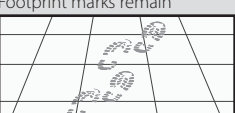
! If daily cleaning has been done using unsuitable detergents		
Slab to be cleaned	What do you see?	What should you do?
KERLITE 3mm KERLITE 3plus KERLITE 5plus DECORS	<p>Opaque stains visible. The floor is glossier than the spare pieces that have not been installed</p> 	<p>Use a detergent such as Tile Cleaner made by <b>Faberchimica</b>. Use product undiluted and let it act for 5 to 10 minutes. Then rub with a white pad, rinse thoroughly with water, soak up any remaining rinsing liquid with a wet vacuum cleaner or a cloth and finally dry with a good quality microfibre cloth, such as MAGIC CLEAN by <b>Bonasytems Italia</b>.</p>
	<p>Opaque stains visible when in contact with various types of liquid.</p> 	
	<p>Footprint marks remain</p> 	

## ■ HEAVY DUTY CLEANING

Slab to be cleaned	Type of dirt	What to use	Instructions	Name of detergent	Supplier
KERLITE 3mm KERLITE 3plus KERLITE 5plus	Coffee, Coca Cola®, fruit juices	Alkaline-based detergent	Follow the instructions supplied by the manufacturer of the detergent.	Coloured stain remover PS87 Super Deterjet Bleach	Faberchimica Fila Geal (various manufacturers)
	Grease, dust from foot traffic, thorough cleaning	Alkaline-based detergent	Follow the instructions supplied by the manufacturer of the detergent.	PS87 Litonet Intensivreiniger HMK R55 Taski R20-strip Bonadecon / Bdecon Deterflash	Fila Litokol Lithofin HMK Johnsondiversey Bonasytems Italia Geal
	Wine	Oxidising detergent	Follow the instructions supplied by the manufacturer of the detergent.	Oxidant Bleach	Faberchimica (various manufacturers)
	Lime residues	Acid-based detergents	Follow the instructions supplied by the manufacturer of the detergent. Test the product on the tiles before use. This applies in particular to honed or polished products.	Viakal	Procter & Gamble
	Rust	Acid-based detergents	Dilute the product and apply directly on the stain. Allow to act for 10/20 minutes then rinse thoroughly. If necessary repeat. Test the product on the tiles before use. This applies in particular to honed or polished products.	Diluted muriatic acid	(various manufacturers)
	Tyre marks, pencil marks and metal marks	Abrasive paste	Follow the instructions supplied by the manufacturer of the detergent. Test the product on the tiles before use. This applies in particular to honed or polished products.	Polishing cream Vim clorex Detergum (*) (*) DO NOT use on honed or polished products.	Faberchimica Guaber Zep Italia
	Ink, felt-tip pen	Solvent-based detergent	Solvents should be applied undiluted directly on the stain. Let them act for about 15/30 seconds. If necessary repeat. As far as "Coloured stain remover" is concerned, follow the manufacturer's instructions.	Nitro thinner Turpentine / white spirit Coloured stain remover	(various manufacturers) (various manufacturers) Faberchimica
	Dirt from grout	Detergent for grout	Follow the instructions supplied by the manufacturer of the detergent.	Fuganet Fugenreiniger	Fila Lithofin
DECORS	Any	Neutral, wax-free detergent	Use water and a neutral, wax-free detergent. DO NOT use alcohol, acids, solvents, abrasive detergents, steel wool or abrasive sponges.	Floor Cleaner Fila Cleaner Pflegerreiniger HMK P15 Bonatitania Clean/Bitania Clean Belgres	Faberchimica Fila Lithofin HMK Bonasytems Italia Geal

## Connecting profiles, finishing and trim pieces



Floor and walls made using any version of KERLITE can be finished with the profiles available on the market.

Hereunder we have listed some possible solutions using the profiles sold by the main manufacturers on the market. The solutions listed hereunder have different technical characteristics and design, depending on the manufacturer. Due to lack of space these are not being presented in detail on this manual. The drawings and instructions are therefore indicative and generic. For more information and to acquire an exhaustive idea of the complete ranges offered, refer to the manufacturer. A list of manufacturers is available in "9 - Useful contacts".



PROFILITEC S.p.A.	www.profilitec.com
SCHLÜTER-SYSTEMS ITALIA S.r.l.	www.schlueter-systems.com
WEDI	www.wedi.it
RARE	www.rareboxdoccia.com





PROGRESS PROFILES	www.progressprofiles.com
PROFILPAS	www.profilpas.com
DURAL	www.dural.de/en

PROFILES FOR DOORS AND WORK TOPS					
	Supplier	Best-selling products			
Full profile		For thick. (mm)	3	3.5	5.5
	Profilitec	Planotec BP	●	●	-
	Progress Profiles	Protop	●	●	-
Profiles with tile compartment		For thick. (mm)	3	3.5	5.5
	Progress Profiles	Protect J, T, Q	●	●	-



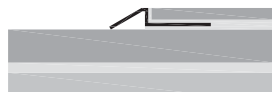



SHOWER SYSTEMS					
	Supplier	Best-selling products			
Stainless steel grid		For thick. (mm)	3	3.5	5.5
	Profilitec	Drain grid	●	●	●
	Schlüter® -Systems	Kerdi-Line-H	●	●	●
	Dural	BASIC-LINE	●	●	●
	Progress Profiles	Proshower Design	●	●	●
	Wedi	Plano Linea	●	●	●
	Profilpas	Drain Invisible	●	●	●
Rare	Ad Hoc	●	●	●	
Grid with tile compartment		For thick. (mm)	3	3.5	5.5
	Schlüter® -Systems	Kerdi-Line-D	●	●	●
	Dural	TI-LINE	●	●	●
	Progress Profiles	Proshower Tile	●	●	●
	Wedi	Riolito piastrellabile	●	●	●
	Rare	Ad Hoc	●	●	●
Shower base system		For thick. (mm)	3	3.5	5.5
	Schlüter® -Systems	Kerdi-Shower	●	●	●
	Dural	TILUX	●	●	●
	Wedi	Fundo Primo / Plano	●	●	●
	Rare	Ad Hoc	●	●	●

WALL/FLOOR AND INNER CORNER					
	Supplier	Best-selling products			
Bullnose		For thick. (mm)	3	3.5	5.5
	Profilitec	BA Bullnose	●	●	●
	Progress Profiles	Bullnose 40	●	●	-
	Profilpas	Metal Line	●	●	-
	Dural	Construct	●	●	●
Bullnose profile		For thick. (mm)	3	3.5	5.5
	Profilitec	BT bullnose	●	●	-
	Progress Profiles	Printer KL ALL	●	●	-
	Profilpas	Proint	●	●	-
Minimum quarter round cove		For thick. (mm)	3	3.5	5.5
	Profilitec	Mosaitec CRM Coflex CR	●	●	●
	Progress Profiles	Proshell D ALL	●	●	-
	Profilpas	Proround/Proint	●	●	-
Quarter round cove		For thick. (mm)	3	3.5	5.5
	Profilitec	Mosaitec CRM Coflex CR	●	●	●
	Progress Profiles	Proshell R ALL	●	●	-
	Profilpas	Proround/Proint	●	●	-
Obtuse angle profiles		For thick. (mm)	3	3.5	5.5
	Profilitec	Sanitec SB	●	●	●
	Schlüter® -Systems	ECK-KHK	●	●	●
	Progress Profiles	Proseal	●	●	-
	Profilpas	Saniboard	●	●	-
	Dural	Duracove	●	●	●
Right angle profiles		For thick. (mm)	3	3.5	5.5
	Schlüter® -Systems	ECK-KI	●	●	●
	Progress Profiles	Probat	●	●	-
	Profilpas	Saniboard	●	●	-

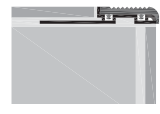
EXPANSION JOINTS		Supplier	Best-selling products		
Floor joints		For thick. (mm)	3	3.5	5.5
	Profilitec	Coflex CAJ Coflex CA	●	●	●
	Schlüter® -Systems	Dilex-BWS	●	●	●
	Progress Profiles	Proflex	●	●	●
	Profilpas	Projoint DIL	●	●	-
	Dural	Duraflex	●	●	●
Perimeter joints		For thick. (mm)	3	3.5	5.5
	Profilitec	Coflex CAJP	●	●	●
	Schlüter® -Systems	Dilex-BWA	●	●	●
	Progress Profiles	Proflex 5 PR	●	●	●
	Profilpas	Projoint DIL	●	●	-
	Dural	Duraflex SF	●	●	●

SURMOUNTED ELEMENTS AND COVERING PROFILES		Supplier	Best-selling products		
Connection		For thick. (mm)	3	3.5	5.5
	Profilitec	Roundjolly RJ	●	●	●
	Schlüter® -Systems	Reno-U	●	●	●
	Progress Profiles	Proslider KL ALL	●	●	-
	Profilpas	Pronivel	●	●	-
Surmounted element		For thick. (mm)	3	3.5	5.5
	Profilitec	Linotec Variotec DK	●	●	●
	Schlüter® -Systems	Reno-T	●	●	●
	Progress Profiles	Profloor 24	●	●	-
	Profilpas	Prolevel	●	●	-
	Dural	LPTE	●	●	●
Straight edge covering profile		For thick. (mm)	3	3.5	5.5
	Profilitec	Squarejolly SJ	●	●	●
	Schlüter® -Systems	Quadec	●	●	●
	Progress Profiles	Projolly Square	●	●	●
	Profilpas	Proangle Q	●	●	●
	Dural	Squareline	●	●	●
Rounded edge covering profile		For thick. (mm)	3	3.5	5.5
	Profilitec	Roundjolly RJ	●	●	●
	Schlüter® -Systems	Rondec	●	●	●
	Progress Profiles	Projolly Quart	●	●	●
	Profilpas	Protrim	●	●	-

CURVED PROFILES		Supplier	Best-selling products		
Metal profile for curves		For thick. (mm)	3	3.5	5.5
	Profilitec	Curveline	●	●	●
	Schlüter® -Systems	Schiene	●	●	●
	Progress Profiles	Curve	●	●	-
	Profilpas	Proflex Line	●	●	-
	Dural	Z-FLEX	●	●	●

STEPS AND OUTER CORNERS		Supplier	Best-selling products		
Profiles for protruding steps		For thick. (mm)	3	3.5	5.5
	Schlüter® -Systems	Rondec	●	●	●
	Progress profiles	Prostyle KL10	●	●	-
	Profilpas	Prostep	●	●	-
Reinforced profiles for steps		For thick. (mm)	3	3.5	5.5
	Schlüter® -Systems	TREP-E	●	●	●
	Profilpas	Prostep SMA	●	●	-
	Dural	Diamondstep	●	●	●
	Progress Profiles	Prostair Acc	●	●	-
	Profilitec	Stairtec FS	●	●	-
Rounded profiles with non-slip tread		For thick. (mm)	3	3.5	5.5
	Profilitec	Stairtec FO	●	●	-
	Schlüter® -Systems	TREP-GK	●	●	●
	Progress Profiles	Prostair KL 20	●	●	-
	Profilpas	Prostep	●	●	-
Rounded profile		For thick. (mm)	3	3.5	5.5
	Profilitec	Roundjolly RJ	●	●	●
	Schlüter® -Systems	Rondec	●	●	●
	Progress Profiles	Projolly Quart	●	●	●
Profilpas	Protrim	●	●	-	
Straight edge profile		For thick. (mm)	3	3.5	5.5
	Profilitec	Squarejolly SJ	●	●	●
	Schlüter® -Systems	Quadec	●	●	●
	Progress Profiles	Projolly Square	●	●	●
	Profilpas	Proangle Q	●	●	●
Dural	Squareline	●	●	●	
Thin corner profile		For thick. (mm)	3	3.5	5.5
	Profilitec	Mosaictec RJF	●	●	●
	Progress Profiles	Prokerlam LINE	●	●	-
	Profilpas	Probord IPA	●	●	-
Corner profiles		For thick. (mm)	3	3.5	5.5
	Profilitec	Stairtec SE	●	●	●
	Schlüter® -Systems	ECK-K	●	●	●
	Progress Profiles	Proedge	●	●	-
	Profilpas	Procorner	●	●	-
	Dural	Duragard	●	●	●

## Making corners during installation

### 7.1 - Solution 1



It is possible to make "handmade" corner finishes with an attractive appearance and without using corner profiles.



1 - Slabs of KERLITE in all types.



2 - Spread adhesive on the support.



3 - Lay the first slab.



4 - Lay the second slab.



5 - Place masking tape on the ends of the slabs.

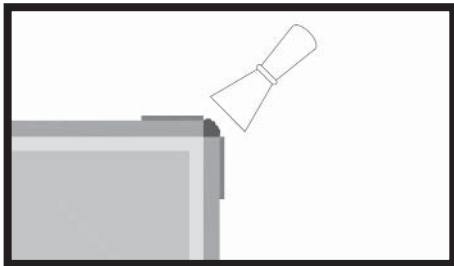

6 - Apply the epoxy grout which matches the porcelain using a trowel.

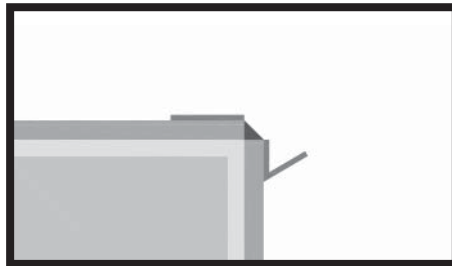

7 - Remove the masking tape.

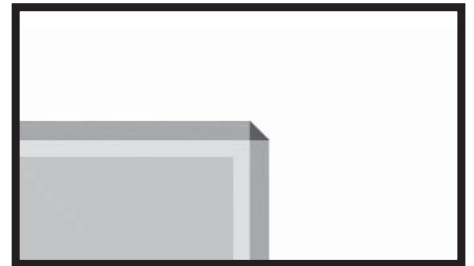

8 - The corner is now ready.

## 7.2 - Solution 2

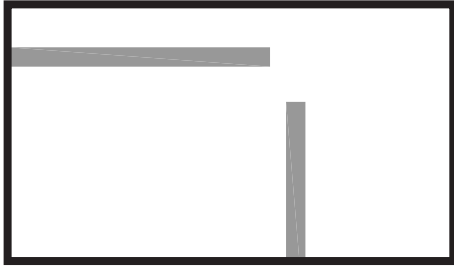

1 - Slabs of KERLITE in all types.

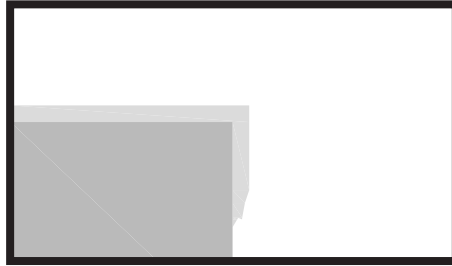

2 - Spread adhesive on the support.

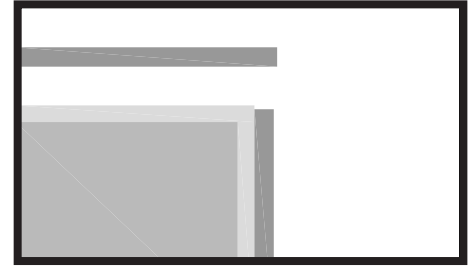

3 - Lay the first slab.

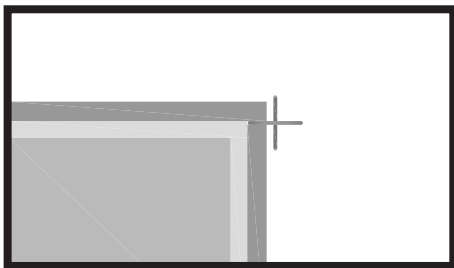

4 - Lay the second slab using 1 mm cross spacers.

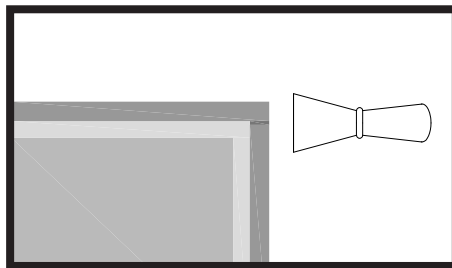

5 - After adhesive has cured, apply epoxy grout with a trowel (\*).

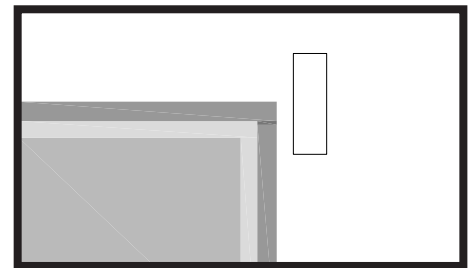

6 - Remove excess grout with a sponge moistened in warm water and alcohol (\*).

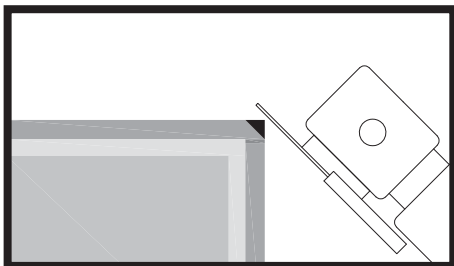

7 - After grout has cured, make a 45° cut with a hand-held angle grinder or grinder fitted on a guide, such as the Jolly-Angle bevelling machine made by **Sigma**. For round chamfers use Bull type guide made by **Raimondi**. (\*)

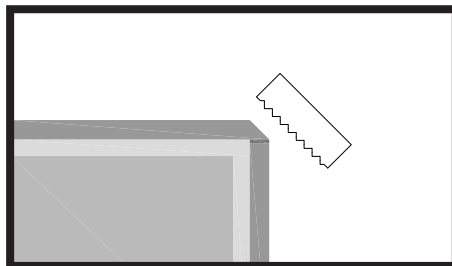

8 - Smoothen the edge with an abrasive sponge.

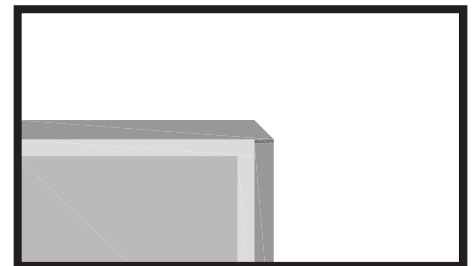

















9 - The corner is now ready.



(\*) This type of product must be removed immediately and thoroughly since epoxy grouts harden very rapidly, even in just a few minutes. Strictly observe the cleaning procedures specified by the manufacturer of the grout used.

## 8.1 - Technical features

Technical features	Test method	Requirements of EN 14411 - G / ISO 13006 - G Group Bia-UGL	Average values KERLITE 3mm	Average values KERLITE 3plus	Average values KERLITE 5plus	
 Water absorption	ISO 10545-3	≤ 0,5%	0,1%	0,1% (*)	0,1% (*)	
 Modulus of rupture	ISO 10545-4	≥ 35 N/mm <sup>2</sup>	50 N/mm <sup>2</sup>	50 N/mm <sup>2</sup>	50 N/mm <sup>2</sup>	
 Deep abrasion resistance	ISO 10545-6	≤ 175 mm <sup>3</sup>	Compliant	Compliant	Compliant	
 Linear thermal expansion	ISO 10545-8	Not required	$\alpha \leq 7 \cdot 10^{-6} \text{ } ^\circ\text{C}^{-1}$	$\alpha \leq 7 \cdot 10^{-6} \text{ } ^\circ\text{C}^{-1}$	$\alpha \leq 7 \cdot 10^{-6} \text{ } ^\circ\text{C}^{-1}$	
 Thermal shock resistance	ISO 10545-9	No alterations	Resistant	Resistant	Resistant	
 Frost-resistance	ISO 10545-12	No alterations	Resistant	Resistant	Resistant	
 Chemical resistance (**)	ISO 10545-13	As indicated by the manufacturer	ULA-UHA Resistant	ULA-UHA Resistant	ULA-UHA Resistant ULB-UHB (Glossy)	
 Stain resistance	ISO 10545-14	Class 3 min.	5 Resistant	5 Resistant ≥ 3 (Soft/Lux)	5 Resistant ≥ 3 (Glossy)	
 Slip resistance	-	-	Not required wall tiles	Refer to the collection catalogue	Refer to the collection catalogue	
 Shading	ANSI A137.1	-	Refer to the collection catalogue	Refer to the collection catalogue	Refer to the collection catalogue	
 Fire reaction	EN 13823 EN 9239-1	CPR (UE) 305/2011, 2000/147/CE, UNI EN 13501-1	Class A1 (walls) Class A1 <sub>f</sub> (flooring)	Class A2-s1,d0 (walls) Class A2 <sub>f</sub> -s1 (flooring)	Class A2-s1,d0 (walls) Class A2 <sub>f</sub> -s1 (flooring)	
 Robinson floor tester (***)	ASTM C627	As indicated by the manufacturer	-	≥ 6 cycles Light Commercial (Over Concrete)	≥ 12 cycles Heavy Commercial (Over Concrete)	
 Thermal conductivity	EN 12524	-	$\lambda = 1,3 \text{ W/m } ^\circ\text{K}$ $\lambda = 0,7 \text{ BTU/ft h } ^\circ\text{F}$	$\lambda = 1,3 \text{ W/m } ^\circ\text{K}$ $\lambda = 0,7 \text{ BTU/ft h } ^\circ\text{F}$	$\lambda = 1,3 \text{ W/m } ^\circ\text{K}$ $\lambda = 0,7 \text{ BTU/ft h } ^\circ\text{F}$	
 Elastic modulus (Young's Modulus)	-	-	55 - 60 GPa	55 - 60 GPa	55 - 60 GPa	
 Density	-	-	2300 -2500 kg/m <sup>3</sup>	2300 -2500 kg/m <sup>3</sup>	2300 -2500 kg/m <sup>3</sup>	
 Sound absorption coefficient $\alpha$	UNI EN ISO 11654	-	0,01 - 0,02	0,01 - 0,02	0,01 - 0,02	
 Size characteristics	Length and width	ISO 10545-2	± 0,6%	Compliant	Compliant	Compliant
	Edge straightness	ISO 10545-2	± 0,5%	Compliant	Compliant	Compliant
	Orthogonality	ISO 10545-2	± 0,6%	Compliant	Compliant	Compliant
	Flatness	ISO 10545-2	± 0,5%	Compliant	Compliant	Compliant
	Thickness	ISO 10545-2	± 5%	Compliant	Compliant	Compliant

(\*) Average value referred to ceramic material only

(\*\*) Excluding hydrofluoridric acid and its derivatives

(\*\*\*) Products with special finishes may have limitations for use; check the individual collection catalogues

## 8.2 - Information for tender specifications

Title	Description
Thickness	<b>KERLITE 3mm:</b> 3 mm
	<b>KERLITE 3plus:</b> 3.5 mm
	<b>KERLITE 5plus:</b> 5.5 mm
Sizes	<b>KERLITE 3mm:</b> refer to the collection catalogue
	<b>KERLITE 3plus:</b> refer to the collection catalogue
	<b>KERLITE 5plus:</b> refer to the collection catalogue
Series and colours	Refer to the collection catalogue
Type of surface	Unglazed (UGL)
Shaping method	Pressing
Water absorption in accordance to EN ISO 10545.3	0,1% (*)
Classification in accordance to EN 14411 / ISO 13006	Group BIa
Reference requirement specifications for first grade tiles	EN 14411 / ISO 13006 Appendix G
Performance classification under	EN - ISO - DIN - B.C.R. Tortus
Declared safety features	Slip resistance <ul style="list-style-type: none"> <li>• Method B.C.R. Tortus method: refer to the collection catalogue</li> <li>• DIN 51130 method: refer to the collection catalogue</li> <li>• DIN 51097 method: refer to the collection catalogue</li> </ul>
	Release of toxic/harmful substances under ISO 10545.15: none
	Fire-resistance (in accordance to Italian laws) (MD 14/01/85, MD 15/03/05, ISO/DIS 1182.2 method) <ul style="list-style-type: none"> <li>• KERLITE 3mm: class 0</li> <li>• KERLITE 3plus: class 1</li> <li>• KERLITE 5plus: class 1</li> </ul>
	Fire-resistance (in accordance to EU standards) (CPR (UE) 305/2011, 2000/147/CE, UNI EN 13501-1) <ul style="list-style-type: none"> <li>• KERLITE 3mm: class A1 (wall installation), class A1<sub>fl</sub> (floor installation)</li> <li>• KERLITE 3plus: class A2-s1,d0 (wall installation), class A2<sub>fl</sub>-s1 (floor installation)</li> <li>• KERLITE 5plus: class A2-s1,d0 (wall installation), class A2<sub>fl</sub>-s1 (floor installation)</li> </ul>
Data for tender specifications	New ceramic mineral produced in 3000x1000 mm slabs of porcelain stoneware, obtained using pure and high quality raw materials (light coloured clays, feldspar fluxes and ceramic pigments with a high chromatic performance). After wet milling, the body is coloured and spray dried, then pressed by compacting on a belt with a force of 15,000 tons and fired at a temperature of 1200°C.

(\*) Average value referred to ceramic material only

## Useful contacts

The companies mentioned in this manual are our own choices and are therefore recommended but not mandatory.

### Adhesives

#### MAPEI S.p.A.

Via Cafiero 22  
20158 (MI) - Italia  
Tel. +39 02 37673  
[www.mapei.it](http://www.mapei.it)

#### KERAKOLL S.p.A

Via dell'Artigianato, 9  
41049 Sassuolo (MO) - Italia  
Tel. +39 0536 811516  
[www.kerakoll.com](http://www.kerakoll.com)

#### LATICRETE S.r.l.

Piazza Martiri, 7  
19020 Brugnato (SP) - Italia  
Tel. +39 0187 897470  
Fax +39 0187 896881  
e-mail [info@laticrete.it](mailto:info@laticrete.it)  
[www.laticrete.it](http://www.laticrete.it)

#### LITOKOL S.p.A

Via G. Falcone, 13/1  
42048 Rubiera (RE) - Italia  
Tel. +39 0522 622811  
Fax. +39 0522 620150  
e-mail [info@litokol.it](mailto:info@litokol.it)  
[www.litokol.it](http://www.litokol.it)

#### WEBER SAINT-GOBAIN

Via Sacco e Vanzetti, 54  
41042 Fiorano Modenese (MO) - Italia  
Tel. +39 0536 837111  
e-mail [info@e-weber.it](mailto:info@e-weber.it)  
[www.e-weber.it](http://www.e-weber.it)

#### PCI - BASF Construction Chemicals Italia S.p.A

Via Vicinale delle corti, 21  
31100 Treviso (TV) - Italia  
Tel. +39 0422 304251  
e-mail [info@vittoriorossi.it](mailto:info@vittoriorossi.it)  
[www.basf-cc.it](http://www.basf-cc.it)

#### ARDEX S.r.l

Via Alessandro Volta, 73 (Località Pigna)  
25015 Desenzano del Garda - Italia  
Tel. +39 0309 119952  
[www.ardex.it](http://www.ardex.it)

### Profiles and trim pieces

#### PROFILITEC S.p.a.

Via Brescia, 42  
36040 Torri di Quartesolo (VI) - Italia  
Tel. +39 0444 268311  
Fax +39 0444 268310  
[www.profilitec.com](http://www.profilitec.com)

#### SCHLÜTER-SYSTEMS Italia S.r.l.

Via Bucciardi 31/33  
41042 Fiorano Modenese (MO)  
Tel. +39 0536 914511  
Fax +39 0536 911156  
[www.schlueter-systems.com](http://www.schlueter-systems.com)

#### PROGRESS PROFILES S.p.A.

Via Le Marze, 7  
31011 Asolo (TV) - Italia  
Tel. +39 0423 950398  
Fax +39 0423 950979  
[www.progressprofiles.com](http://www.progressprofiles.com)

#### PROFILPAS S.p.A.

Via Einstein, 38  
35010 Cadoneghe (PD) - Italia  
Tel. +39 049 8878411  
Fax +39 049 706692  
[www.profilpas.com](http://www.profilpas.com)

#### DURAL GmbH & Co.

Via Oberdan, 11  
40126 Bologna (BO) - Italia  
Tel. +39 051 0971513  
Fax +39 051 0971513  
[www.dural.com](http://www.dural.com)

#### WEDI ITALIA S.r.l.

Via Redipuglia, 32  
20035 Lissone (MI) - Italia  
Tel. +39 0392 459420  
[www.wedi.it](http://www.wedi.it)

#### RARE S.r.l

Via delle Brughiere, 12  
21050 Cairate (VA) - Italia  
Tel. +39 0331 360360  
Fax +39 0331 360168  
[www.rareboxdoccia.com](http://www.rareboxdoccia.com)

### Detergents

#### MAPEI S.p.A.

Via Cafiero 22  
20158 (MI) - Italia  
Tel. +39 02 37673  
[www.mapei.it](http://www.mapei.it)

#### FABERCHIMICA S.r.l.

via G. Ceresani, 10 - Località Campo d'Olmo  
60044 Fabriano (AN) - Italia  
Tel. +39 0732 627178  
[www.faberchimica.com](http://www.faberchimica.com)

#### FILA Industria Chimica S.p.A.

via Garibaldi, 32  
35018 S. Martino dei Lupari (PD) - Italia  
Tel. +39 049 9467300  
[www.filachim.it](http://www.filachim.it)

#### ZEP Italia S.r.l.

via Nettunese, Km 25,000  
04011 Aprilia (LT) - Italia  
Tel. +39 06 926691  
[www.zepitalia.it](http://www.zepitalia.it)

#### JOHNSON DIVERSEY S.p.A.

via Meucci, 40  
20128 Milano - Italia  
Tel. +39 0373 2051  
[www.johnsondiversey.com](http://www.johnsondiversey.com)

#### KITER S.r.l.

via Assiano, 7/B  
20019 Settimo Milanese (MI) - Italia  
Tel. +39 02 3285220  
[www.kiter.it](http://www.kiter.it)

#### GEAL S.r.l.

via Settola, 121  
51031 Agliana (PT) - Italia  
Tel. +39 0574 750365  
[www.geal-chim.it](http://www.geal-chim.it)

#### FEDERCHEMICALS S.r.l.

via G. Borsi, 2  
25128 - Brescia - Italia  
Tel. +39 030 3390880  
Fax +39 030 3385580  
[www.federchemicals.it](http://www.federchemicals.it)



## Detergents

---

### LITHOFIN-Produkte GmbH

Postfach 1134,  
D-73236 Wendlingen (D)  
Tel. 0049 07024/940320  
[www.lithofin.de](http://www.lithofin.de)  
Vertrieb für Österreich:  
CT-Austria Ges.m.b.H. A-1230 Wien  
Tel. +43 01 8673434

### HMK - MÖLLER-CHEMIE

Benelux GmbH - Linge 4  
NL-2105 WB Heemstede (NL)  
Tel. +31 0252 220222  
[www.moellerchemie.de](http://www.moellerchemie.de)

### BONASYSTEMS ITALIA S.r.l.

Via Borgo S. Chiara, 29  
30020 Torre di Mosto (VE) - Italia  
Tel. +39 0421 325691  
Fax +39 0421 324232  
[www.bonasytemsitalia.it](http://www.bonasytemsitalia.it)

### LITOKOL S.p.A

Via G. Falcone, 13/1  
42048 Rubiera (RE) - Italia  
Tel. +39 0522 622811  
Fax. +39 0522 620150  
e-mail [info@litokol.it](mailto:info@litokol.it)  
[www.litokol.it](http://www.litokol.it)

### Uncoupling mats, soundproofing mats etc.

---

### SCHLÜTER-SYSTEMS Italia S.r.l.

Via Bucciardi 31/33  
41042 Fiorano Modenese (MO)  
Tel. +39 0536 914511  
Fax +39 0536 911156  
[www.schlueter-systems.com](http://www.schlueter-systems.com)

### GUTJAHR Systemtechnik GmbH

Philipp-Reis-Str. 5-7  
D-64404 Bickenbach/Bergstraße  
Tel. +49 0 62 57 - 93 06-0  
Fax +49 0 62 57 - 93 06-31  
[www.gutjahr.com](http://www.gutjahr.com)

### MAPEI S.p.A.

Via Cafiero 22  
20158 (MI) - Italia  
Tel. +39 02 37673  
[www.mapei.it](http://www.mapei.it)

## Notched and rubber coated trowels

---

### RAIMONDI S.r.l.

Via Dalla Casta, 300/A  
41100 Modena (MO) - Italia  
Tel. +39 059 280888  
Fax +39 059 282808  
[www.raimondiutensili.it](http://www.raimondiutensili.it)

## Plaster

---

### FASSA BORTOLO S.p.A.

via Lazzaris, 3  
31027 Spresiano (TV) - Italia  
Tel. +39 0422 7222  
Fax +39 0422 887509  
[www.fassabortolo.com](http://www.fassabortolo.com)

### FORNACI CALCI GRIGOLIN S.p.A.

via Foscarini, 2  
31040 Nervesa della Battaglia (TV)  
Tel. 800350907  
[www.fornacigrigolin.it](http://www.fornacigrigolin.it)

## Holesaws / Diamond and abrasive discs Drill bits

---

### DIAMANT CENTER - TYROLIT S.r.l.

Via Valle d'Aosta, 12  
41049 Sassuolo (MO) - Italia  
Tel. +39 0536 808166  
Fax +39 0536 808211  
[www.diamantcenter.it](http://www.diamantcenter.it)

### MONTOLIT S.p.A.

Via Turconi, 25  
21050 Cantello (VA) - Italia  
Tel. +39 0332 419211/417744  
e-mail [info@montolit.com](mailto:info@montolit.com)  
[www.montolit.com](http://www.montolit.com)

### RAIMONDI S.r.l.

Via Dalla Casta, 300/A  
41100 Modena (MO) - Italia  
Tel. +39 059 280888  
Fax +39 059 282808  
[www.raimondiutensili.it](http://www.raimondiutensili.it)

## Holesaws / Diamond and abrasive discs Drill bits

---

### RUBI ITALIA S.r.l.

Via Radici in Piano, 596/A  
41049 Sassuolo (MO) - Italy  
Tel. +39 0536 810984  
Fax +39 0536 810987  
[www.rubi.com](http://www.rubi.com)

### WÜRTH S.r.l.

Via Stazione, 51  
39044 Egna (BZ) - Italia  
Tel. +39 06 90779001  
Fax +39 06 90386201  
[www.eshop.wuerth.it](http://www.eshop.wuerth.it)

## Tile cutters / Glass cutters Abrasive sponges

---

### BOHLE ITALIA S.r.l.

Via Cavallotti, 28  
20081 Abbiategrasso (MI) - Italia  
Tel. +39 02 94967790  
Fax +39 02 94609011  
[www.bohle-group.com/it](http://www.bohle-group.com/it)

### WÜRTH S.r.l.

Via Stazione, 51  
39044 Egna (BZ) - Italia  
Tel. +39 06 90779001  
Fax +39 06 90386201  
[www.eshop.wuerth.it](http://www.eshop.wuerth.it)

## Tile cutter rulers

---

### SIGMA S.n.c.

Via A. Gagliani, 4  
47813 Igea Marina Bellaria (RN) - Italia  
Tel. +39 0541 330103  
Fax +39 0541 330422  
[www.sigmailia.com](http://www.sigmailia.com)

### RAIMONDI S.r.l.







Via Dalla Casta, 300/A  
41100 Modena (MO) - Italia  
Tel. +39 059 280888  
Fax +39 059 282808  
[www.raimondiutensili.it](http://www.raimondiutensili.it)

# Adhesives attachment

As a general rule that applies for all building materials to be fixed in place with adhesive, there is no universal adhesive for installing KERLITE on all kinds of surface. Since it is not possible to describe all possible cases, we have provided information about the most common situations. First of all, we have divided installation cases into "walls" and "floors" and then into "interior" and "exterior". Depending on the hypothetical stress, on any work to be performed subsequently and on the maximum dimension of the slab, we have assigned a certain type of KERLITE to each category. Starting from this classification, we have thus examined the most common kinds of supporting material. The resulting chart has been sent to all main manufacturers of adhesives that have, in turn, provided the most suitable product for each category.

Please note that all solutions suggested have been submitted by adhesive manufacturers, who guarantee the indications given. For explanations or more information, contact the product manufacturers (see "9 - Useful contacts").

**It is essential to follow all instructions given by adhesive manufacturers. This applies in particular to waiting times before a surface is "set for light foot traffic", "ready for grouting" and "ready to use" that are indicated in the following tables.**

	<b>WALL INSTALLATION(*)</b> For NEW BUILDINGS and RENOVATION projects that require installation on pre-existing wall cladding			
 <b>Interiors</b>	Any residential and commercial environment, in situations where holes and/or cuts are <b>not</b> necessary.	KERLITE 3mm	Two-coat plaster, gypsum plaster, plasterboard, fibre cement panels  Concrete, old ceramic tiles, marble, stone  Particle board, metal	Pag. 34  Pag. 35  Pag. 36
 <b>Exteriors</b>	In situations where holes and/or cuts are <b>not</b> necessary and with sizes up to 100x100 cm.	KERLITE 3mm	Plaster  Concrete	Pag. 40  Pag. 41
	In situations where holes and/or cuts are necessary and/or for large sizes.	KERLITE 3plus KERLITE 5plus	Two-coat plaster, gypsum plaster, plasterboard, fibre cement panels  Concrete, old ceramic tiles, marble, stone  Particle board, metal	Pag. 37  Pag. 38  Pag. 39
	<b>FLOOR INSTALLATION(*)</b> For NEW BUILDINGS and RENOVATION projects that require installation on pre-existing floor coverings			
 <b>Interiors</b>	<b>Residential</b> (kitchens, bathrooms, living rooms, common apartment block areas and any other residential environment).	KERLITE 3plus KERLITE 5plus	Cement-based screeds, calcium sulphate-based or heated screeds, self-levelling products, concrete, old ceramic tiles, marble slabs, stone	Pag. 44
	<b>Light commercial</b> (offices, offices open to the general public, waiting rooms, shops, bathrooms, restaurant dining rooms, car showrooms, bars, cinemas, surgeries/clinics).	KERLITE 3plus KERLITE 5plus	Hardwood, PVC, rubber, linoleum, metal, resin	Pag. 45
	<b>Intensive commercial</b> (common areas of shopping centres, hotel foyers, canteens, fast food restaurants, dance clubs, hospitals) with the exception of areas subject to heavy concentrated loads (e.g. trolleys with hard wheels).	KERLITE 5plus	Cement-based screeds, calcium sulphate-based or heated screeds, self-levelling products, concrete, old ceramic tiles, marble slabs, stone  Hardwood, PVC, rubber, linoleum, metal, resin	Pag. 44  Pag. 45
 <b>Exteriors</b>	Upon condition that surfaces are sheltered (e.g. loggias, covered balconies, etc.) and made totally impervious. We recommend the use of sizes that have sides not exceeding 100 cm.	KERLITE 3plus KERLITE 5plus	Cement-based screeds, calcium sulphate-based or heated screeds, self-levelling products, concrete, old ceramic tiles, marble slabs, stone  Hardwood, PVC, rubber, linoleum, metal, resin	Pag. 44  Pag. 45

(\*) Products with special finishes can have limitations depending on their area of application. Refer to specific collection catalogues.

## How to read the **attachment**

At the discretion of P.S.	Supplier	Size of slabs (cm)	Product (*) (****)	Primer, if necessary (*) (****)	Mixing ratio (* *)	Class (*)	Nominal coverage (*)	Set for light foot traffic and ready for grouting times (***)	Ready for use (***)	Installation (*)
01	02	03	04	05	06	07	08	09	10	11

- 01**\_ The project supervisor must examine the conditions of the work site to choose between a normal setting adhesive or a quick setting.
- 02**\_ List of adhesive manufacturers.
- 03**\_ The size in cm of the slab is indicated according to the adhesive recommended by the manufacturer.
- 04**\_ List of adhesives recommended by manufacturers based on the intended use and size of slabs.
- 05**\_ List of primers to use before adhesive application, as indicated by manufacturers for each intended use.
- 06**\_ The mixing ratio refers to a single product unit (a bag, a can, etc.), in order to obtain the characteristics declared by manufacturers.
- 07**\_ The adhesive's class under the UNI EN 12004 standard is indicated (see Sheet below "About ADHESIVES").
- 08**\_ Indication of how many square metres one can install with a single product unit prepared with the indicated mixing ratio.
- 09**\_ Time that must pass before treading on the surface to fill joints with grout.
- 10**\_ Time that must pass before using the floor, i.e. before it can be subjected to static and/or dynamic loads.
- 11**\_ Installation method and features of the trowel to use for each adhesive.

### About ADHESIVES

**Adhesives are divided into THREE CLASSES, depending on their chemical composition, as established by the UNI EN 12004 standard:**

CEMENTITIOUS (**C**): mixture of hydraulic binding agents, aggregates and organic additives  
(N.B.: to be mixed with water or other liquid additive immediately before use)

REACTIVE (**R**): mixture of synthetic resin, mineral fillers and organic additives, which harden due to a chemical reaction  
(N.B.: these adhesives may have one or more components)

IN DISPERSION (**D**): mixture of binding and organic agents, namely polymers in aqueous dispersion, organic additives and mineral fillers  
(N.B.: ready-to-use mixtures)

**Depending on their features, adhesives are thus classified:**

Class **1**: normal setting adhesives

Class **2**: improved setting adhesives

**There are three optional classes:**

Class **F**: quick setting adhesives

Class **T**: slip resistant adhesives

Class **E**: adhesives with extended open time

**There is a fourth additional class for cementitious adhesives only: adhesives can be classified as DEFORMABLE (S) and divided on the basis of test results under the UNI EN 12002 standard:**



Class **S1**: deformable adhesives

Class **S2**: highly deformable adhesives

# A.1a - Wall installation in interiors of KERLITE 3mm



**Substrate:** two-coat plaster, gypsum plaster, plasterboard, fibre cement panels.

At the discretion of P.S.	Supplier	Size of slabs (cm)	Product (*) (****)	Primer, if necessary (*) (****)	Mixing ratio (* *)	Class (*)	Nominal coverage (*)	Set for light foot traffic and ready for grouting times (**)	Ready for use (***)	Installation (*)
 <p>For situations in which a normal setting adhesive is recommended</p>	MAPEI	50x50; 100x40; 100x50	KERAFLEX MAXI S1	MANDATORY for gypsum-based, anhydrite or absorbent surfaces: Primer G or ECOPRIM T	1 bag (25 kg) + 7/7.7 litres of water	C2 TE S1	7 m <sup>2</sup>	8 hours	14 days	Installation with substrate and tile troweling of adhesive
			ULTRALITE S1		1 bag (15 kg) + 8.4/8.7 litres of water	C2 TE S1				
		100x100; 300x100	ULTRALITE S2		1 bag (15 kg) + 5.9/6.2 litres of water	C2 E S2	6.3 m <sup>2</sup>			
			KERABOND + ISOLASTIC		1 bag (25 kg) + 8.5 kg of ISOLASTIC	C2 E S2	6,5 m <sup>2</sup>			
	KERAKOLL	All sizes	H40 NO LIMITS	For gypsum-based surfaces: Primer A Eco	Grey 1 bag (25 kg) from 7,1 to 8,5 litres of water White 1 bag (25 kg) from 7,2 to 9,5 litres of water	C2 TE	6 m <sup>2</sup>	20 hours	3 days	
	LATICRETE	All sizes	LATICRETE 254 Platinum	Not necessary, according to manufacturer	1 bag (25 kg) + 6 litres of water	C2 TE S1	5 m <sup>2</sup>	1 day	14 days	
	LITOKOL	All sizes	SUPERFLEX K77	For gypsum-based surfaces: Primer C	1 bag (25 kg) + 8.5 litres of water	C2 TE S1	6 m <sup>2</sup>	8 hours	14 days	
	PCI - BASF	All sizes	PCI FLEXMOERTEL S1	For gypsum-based surfaces: PCI GISOGRUND	1 bag (20 kg) + 7.4 litres of water	C2 TE S1	7.1 m <sup>2</sup>	12 hours	3 days	
SAINT-GOBAIN / WEBER	50x50; 100x40; 100x50	WEBER.COL UltraGres Evo	For gypsum-based surfaces: WEBER.PRIM PF15	1 bag (25 kg) + 6.7/7 litres of water	C2 TE S1	6 m <sup>2</sup>	8 hours	14 days		
		100x100; 300x100		WEBER.COL UltraGres Top	1 bag (25 kg) + 6.7/7 litres of water				C2 TE S2	
ARDEX	All sizes	ARDEX X 77 Microtec	For gypsum-based surfaces: ARDEX P 51	1 bag (25 kg) + 11 litres of water	C2 T(T) E(E) S1	10 m <sup>2</sup>	8 hours	1 day	Installation with substrate troweling of adhesive (6 mm trowel)	
 <p>For situations in which a quick setting adhesive is recommended</p>	MAPEI	50x50; 100x40; 100x50	KERAQUICK S1	MANDATORY for gypsum-based, anhydrite or absorbent surfaces: Primer G or ECOPRIM T	Grey 1 bag (25 kg) + 5,5/6 litres of water	C2 FTE S1	6.3 m <sup>2</sup>	3 hours	1 day	Installation with substrate and tile troweling of adhesive
			White 1 bag (23 kg) + 4.8/5.3 litres of water		5.8 m <sup>2</sup>					
		100x100; 300x100	GRANIRAPID		Component A: 1 bag (25 kg) Component B: tub (5,5 kg)	C2 FE S1	6 m <sup>2</sup>			
	KERAKOLL	All sizes	H40 REVOLUTION	For gypsum-based surfaces: Primer A Eco	Grey 1 bag (25 kg) from 6 to 7 litres of water	C2 FTE	6 m <sup>2</sup>	2 hours	1 day	
					White 1 bag (25 kg) from 6 to 7,3 litres of water					
	LATICRETE	All sizes	LATICRETE 335 Rapid Super Flex + LATICRETE 282 Latex Additive	Not necessary, according to manufacturer	1 bag (25 kg) + 6/7 litres of latex	C2 TE F	5 m <sup>2</sup>	6 hours	2 days	
	LITOKOL	All sizes	LITOSTONE K99 + LATEXKOL + water	For gypsum-based surfaces: Primer C	1 bag (25 kg) + 3.5 litres of LATEXKOL + 3.5 litres of water	C2 FE S1	5 m <sup>2</sup>	4 hours	1 day	
	PCI - BASF	All sizes	PCI FLEXMOERTEL S1 RAPID	For gypsum-based surfaces: PCI GISOGRUND	1 bag (20 kg) + 9 litres of water	C2 FT S1	6.5 m <sup>2</sup>	3 hours	1 day	
SAINT-GOBAIN / WEBER	All sizes	WEBER.COL PRO UltraGres Fast	For gypsum-based surfaces: WEBER.PRIM PF15	1 bag (25 kg) + 6/6,3 litres of WEBER L50	C2 FTE S1	6 m <sup>2</sup>	3 hours	1 day		
ARDEX	All sizes	ARDEX X 77 S microtec	For gypsum-based surfaces: ARDEX P 51	1 bag (25 kg) + 8.5 litres of water	C2 FT(T) E S1	10 m <sup>2</sup>	90 min.	6 hours	Installation with substrate troweling of adhesive (6 mm trowel)	

(\*) Instructions provided directly by manufacturers, who guarantee the information given.

For explanations or more details, contact the technical support offices of the product manufacturers (see "9 - Useful contacts").



(\*\*) Instructions provided directly by manufacturers, who guarantee the information given. If a product is offered in both "white" and a "grey" versions, the mixing ratio may vary. For explanations or more details, contact the technical support offices of the product manufacturers (see "9 - Useful contacts").

(\*\*\*) Ratings provided directly by manufacturers, who guarantee the information given, are based on laboratory tests performed at 23° C and with a relative humidity of 50%. In the event of use in different situations or for explanations or more details, contact the technical support offices of the product manufacturers (see "9 - Useful contacts").

## A.1b - Wall installation in interiors of KERLITE 3mm



**Substrate:** concrete, old ceramic tiles, marble, stone.

At the discretion of P.S.	Supplier	Size of slabs (cm)	Product (*) (***)	Primer, if necessary (*) (****)	Mixing ratio (* *)	Class (*)	Nominal coverage (*)	Set for light foot traffic and ready for grouting times (**)	Ready for use (***)	Installation (*)
 <p>For situations in which a normal setting adhesive is recommended</p>	MAPEI	50x50; 100x40; 100x50	KERAFLEX MAXI S1	If levelling is necessary, on the mentioned supports, apply ECOPRIM GRIP beforehand	1 bag (25 kg) + 8/8.5 litres of water	C2 TE	6.3 m <sup>2</sup>	8 hours	14 days	Installation with substrate and tile troweling of adhesive
			ULTRALITE FLEX		Grey 1 bag (15 kg) + 8.1/8.4 litres of water	C2 TE	7 m <sup>2</sup>			
		100x100; 300x100	ULTRALITE S1		White 1 bag (15 kg) + 8.2/8.5 Litres of water	C2TES1	7 m <sup>2</sup>			
			KERAFLEX MAXI S1		1 bag (15 kg) + 8.4/8.7 litres of water	C2TES1	7 m <sup>2</sup>			
	KERAKOLL	All sizes	H40 NO LIMITS	Not necessary, according to manufacturer	Grey 1 bag (25 kg) from 7.1 to 8.5 litres of water	C2 TE	6 m <sup>2</sup>	20 hours	3 days	
					White 1 bag (25 kg) from 7.2 to 9.5 litres of water					
	LATICRETE	All sizes	LATICRETE 254 Platinum	Not necessary, according to manufacturer	1 bag (25 kg) + 6 litres of water	C2 TE S1	5 m <sup>2</sup>	1 day	7 days	
	LITOKOL	All sizes	SUPERFLEX K77	Not necessary, according to manufacturer	1 bag (25 kg) + 8.5 litres of water	C2 TE S1	6 m <sup>2</sup>	8 hours	7 days	
	PCI - BASF	All sizes	PCI FLEXMOERTEL S1	For gypsum-based surfaces: PCI GISOGRUND	1 bag (20 kg) + 7.4 litres of water	C2 TE S1	7.1 m <sup>2</sup>	12 hours	3 days	
	SAINT-GOBAIN / WEBER	50x50; 100x40; 100x50	WEBER.COL UltraGres Top	For old ceramic tiles, marble slabs and stone: WEBER.FLOOR 4716 Primer	1 bag (25 kg) + 6.7/7 litres of water	C2 TE S1	6 m <sup>2</sup>	8 hours	14 days	
100x100; 300x100		WEBER.COL UltraGres Top + WEBER L50	1 bag (15 kg) + 7 litres of WEBER L50		C2 TE S2					
ARDEX	All sizes	ARDEX X 77 Microtec	For old ceramic tiles, marble slabs and stone, or alternatively: - ARDEX P 4 - ARDEX X 77 (rough levelled)	1 bag (25 kg) + 11 litres of water	C2 T(T) E(E) S1	10 m <sup>2</sup>	8 hours	1 day	Installation with substrate troweling of adhesive (6 mm trowel)	
 <p>For situations in which a quick setting adhesive is recommended</p>	MAPEI	50x50; 100x40; 100x50	KERAQUICK S1	MANDATORY for gypsum-based, anhydrite or absorbent surfaces: Primer G or ECOPRIM T	Grey 1 bag (25 kg) + 5.5/6 litres of water	C2F TS1	6.3 m <sup>2</sup>	3 hours	1 day	Installation with substrate and tile troweling of adhesive
			White 1 bag (23 kg) + 4.8/5.3 litres of water		5.8 m <sup>2</sup>					
		100x100; 300x100	GRANIRAPID		Component A: 1 bag (25 kg) Component B: tub (5.5 kg)	C2 FS1	6 m <sup>2</sup>			
			ULTRALITE S1 QUICK		1 bag (45 kg) + 5.1/5.7 litres of water	C2 FTE S1	6 m <sup>2</sup>			
	KERAKOLL	All sizes	H40 REVOLUTION	Not necessary, according to manufacturer	Grey 1 bag (25 kg) from 6 to 7 litres of water	C2F TE	6 m <sup>2</sup>	2 hours	1 day	
					White 1 bag (25 kg) from 6 to 7.3 litres of water					
	LATICRETE	All sizes	LATICRETE 335 Rapid Super Flex + LATICRETE 282 Latex Additive	Not necessary, according to manufacturer	1 bag (25 kg) + 6/7 litres of latex	C2 TE F	5 m <sup>2</sup>	6 hours	2 days	
	LITOKOL	All sizes	LITOSTONE K99 + LATEXKOL + water	Not necessary, according to manufacturer	1 bag (25 kg) + 3.5 litres of LATEXKOL + 3.5 litres of water	C2 FE S1	5 m <sup>2</sup>	4 hours	1 day	
	PCI - BASF	All sizes	PCI FLEXMOERTEL S1 RAPID	For gypsum-based surfaces: PCI GISOGRUND	1 bag (20 kg) + 9 litres of water	C2 FT S1	6.5 m <sup>2</sup>	3 hours	1 day	
	SAINT-GOBAIN / WEBER	All sizes	WEBER.COL UltraGres Fast	For old ceramic tiles, marble slabs and stone: WEBER.FLOOR 4716 Primer	1 bag (25 kg) + 6/6.3 litres of WEBER L50	C2 FTE S1	6 m <sup>2</sup>	3 hours	1 day	
ARDEX	All sizes	ARDEX X 77 S microtec	For old ceramic tiles, marble slabs and stone, or alternatively: - ARDEX P 4 - ARDEX X 77 (rough levelled)	1 bag (25 kg) + 8.5 litres of water	C2 FT(T) E S1	10 m <sup>2</sup>	90 min.	6 hours	Installation with substrate troweling of adhesive (6 mm trowel)	

(\*) Instructions provided directly by manufacturers, who guarantee the information given.  
For explanations or more details, contact the technical support offices of the product manufacturers (see "9 - Useful contacts").

(\*\*) Instructions provided directly by manufacturers, who guarantee the information given. If a product is offered in both "white" and a "grey" versions, the mixing ratio may vary.  
For explanations or more details, contact the technical support offices of the product manufacturers (see "9 - Useful contacts").



(\*\*\*) Ratings provided directly by manufacturers, who guarantee the information given, are based on laboratory tests performed at 23° C and with a relative humidity of 50%.  
In the event of use in different situations or for explanations or more details, contact the technical support offices of the product manufacturers (see "9 - Useful contacts").

(\*\*\*\*) Product names shown may vary according to destination countries in relation to the commercial assessment of the manufacturer.

# A.1c - Wall installation in interiors of KERLITE 3mm



**Substrate:** particle board, metal.

At the discretion of P.S.	Supplier	Size of slabs (cm)	Product (*) (****)	Primer, if necessary (*) (****)	Mixing ratio (* *)	Class (*)	Nominal coverage (*)	Set for light foot traffic and ready for grouting times (**)	Ready for use (***)	Installation (*)
 <p>For situations in which a normal setting adhesive is recommended</p>	MAPEI	All sizes	ULTRABOND ECO PU 2K	Not necessary, according to manufacturer	1 bucket (10 kg)	R2T	3 m <sup>2</sup>	12 hours	7 days	Installation with substrate and tile troweling of adhesive
			KERALASTIC		1 bucket (10 kg)	R2				
			KERALASTIC T		1 bucket (10 kg)	R2T				
	KERAKOLL	All sizes	H40 NO LIMITS	KERAGRIP ECO	Grey 1 bag (25 kg) from 7.1 to 8.5 litres of water White 1 bag (25 kg) from 7.2 to 9.5 litres of water	C2 TE	6 m <sup>2</sup>	20 hours	3 days	
			H40 EXTREME	Not necessary, according to manufacturer	1 bucket (10 kg)	R2	4 m <sup>2</sup>	4 hours	12 hours	
	LATICRETE	All sizes	LATALASTIK	Not necessary, according to manufacturer	1 bucket of component A (5 kg) 1 bucket of component B (2 kg)	R2T	3 m <sup>2</sup>	1 day	7 days	
	LITOKOL	All sizes	LITOELASTIC	Not necessary, according to manufacturer	1 bucket (10 kg)	R2T	3 m <sup>2</sup>	12 hours	5 days	
	PCI - BASF	All sizes	PCI FLEXMOERTEL S1	For gypsum-based surfaces: PCI GISOGRUND	1 bag (20 kg) + 7.4 litres of water	C2 TE S1	7.1 m <sup>2</sup>	12 hours	3 days	
SAINT-GOBAIN / WEBER	All sizes	FIX CR	Not necessary, according to manufacturer	1 bucket (10 kg)	R2T	3 m <sup>2</sup>	12 hours	2 days		
ARDEX	All sizes	ARDEX X 77 microtec	ARDEX P 82	1 bag (25 kg) + 11 litres of water	C2 T(T) E(E) S1	10 m <sup>2</sup>	8 hours	1 day	Installation with substrate troweling of adhesive (6 mm trowel)	
 <p>For situations in which a quick setting adhesive is recommended</p>	MAPEI	All sizes	KERAQUICK + LATEX PLUS	Not necessary, according to manufacturer	1 bag (25 kg) + 8.5 kg of LATEX PLUS	C2 FT S2	7 m <sup>2</sup>	3 hours	1 day	Installation with substrate and tile troweling of adhesive
	KERAKOLL	All sizes	H40 REVOLUTION	KERAGRIP ECO	Grey 1 bag (25 kg) from 6 to 7 litres of water White 1 bag (25 kg) from 6 to 7.3 litres of water	C2 FT E	6 m <sup>2</sup>	2 hours	1 day	
			H40 EXTREME	Not necessary, according to manufacturer	1 bucket (10 kg)	R2	4 m <sup>2</sup>	4 hours	12 hours	
	LATICRETE	All sizes	LATALASTIK	Not necessary, according to manufacturer	1 bucket of component A (5 kg) 1 bucket of component B (2 kg)	R2T	2 m <sup>2</sup>	1 day	7 days	Installation with substrate troweling of adhesive (6 mm trowel)
	LITOKOL	All sizes	LITOELASTIC	Not necessary, according to manufacturer	1 bucket (10 kg)	R2T	3 m <sup>2</sup>	12 hours	5 days	Installation with substrate and tile troweling of adhesive
	PCI - BASF	All sizes	PCI FLEXMOERTEL S1 RAPID	For gypsum-based surfaces: PCI GISOGRUND	1 bag (20 kg) + 9 litres of water	C2 FT S1	6.5 m <sup>2</sup>	3 hours	1 day	
	SAINT-GOBAIN / WEBER	All sizes	WEBER.COL FIX CR	Not necessary, according to manufacturer	1 bucket (10 kg)	R2T	3 m <sup>2</sup>	12 hours	2 days	
	ARDEX	All sizes	ARDEX X 77 S microtec	ARDEX P 82	1 bag (25 kg) + 8.5 litres of water	C2 FT(T) E S1	10 m <sup>2</sup>	90 min.	6 hours	Installation with substrate troweling of adhesive (6 mm trowel)

(\*) Instructions provided directly by manufacturers, who guarantee the information given.

For explanations or more details, contact the technical support offices of the product manufacturers (see "9 - Useful contacts").



(\*\*) Instructions provided directly by manufacturers, who guarantee the information given. If a product is offered in both "white" and a "grey" versions, the mixing ratio may vary. For explanations or more details, contact the technical support offices of the product manufacturers (see "9 - Useful contacts").

(\*\*\*) Ratings provided directly by manufacturers, who guarantee the information given, are based on laboratory tests performed at 23° C and with a relative humidity of 50%. In the event of use in different situations or for explanations or more details, contact the technical support offices of the product manufacturers (see "9 - Useful contacts").

## A.2a - Wall installation in interiors of KERLITE 3plus and KERLITE 5plus



**Substrate:** two-coat plaster, gypsum plaster, plasterboard, fibre cement panels

At the discretion of P.S.	Supplier	Size of slabs (cm)	Product (*) (***)	Primer, if necessary (*) (****)	Mixing ratio (* *)	Class (*)	Nominal coverage (*)	Set for light foot traffic and ready for grouting times (**)	Ready for use (***)	Installation (*)
 For situations in which a normal setting adhesive is recommended	MAPEI	50x50; 100x40; 100x50	KERAFLEX MAXI S1	MANDATORY for gypsum-based, anhydrite or absorbent surfaces: Primer G or ECOPRIM T	1 bag (25 kg) + 7,2/7,7 litres of water	C2 TE S1	7 m <sup>2</sup>	8 hours	14 days	Installation with substrate and tile troweling of adhesive
			ULTRALITE S1		1 bag (15 kg) + 8,4/8,7 litres of water	C2 TE S1				
		100x100; 300x100	ULTRALITE S2		1 bag (15 kg) + 5,9/6,2 litres of water	C2 E S2	6,3 m <sup>2</sup>			
			KERABOND + ISOLASTIC		1 bag (25 kg) + 8,5 kg ISOLASTIC	C2 E S2	6,5 m <sup>2</sup>			
	KERAKOLL	All sizes	H40 NO LIMITS	For gypsum-based surfaces: Primer A Eco	Grey 1 bag (25 kg) from 7.1 to 8.5 litres of water	C2 TE	6 m <sup>2</sup>	20 hours	3 days	
					White 1 bag (25 kg) from 7.2 to 9.5 litres of water					
	KERAKOLL	All sizes	H40 EXTREME	For gypsum-based surfaces: SLC ECO EP 21	1 bucket (10 kg)	R2	4 m <sup>2</sup>	4 hours	12 hours	
					LATICRETE	All sizes	LATICRETE 254 Platinum	Not necessary, according to manufacturer	1 bag (25 kg) + 6 litres of water	
	LITOKOL	50x50; 100x40; 100x50	SUPERFLEX K77	For gypsum-based surfaces: Primer C	1 bag (25 kg) + 8,5 litres of water	C2 TE S1	6 m <sup>2</sup>	8 hours	7 days	
			HYPERFLEX K100		1 bag (20 kg) + 7 litres of water	C2 TE S2	6 m <sup>2</sup>			
PCI - BASF	All sizes	PCI FLEXMOERTEL S2	For gypsum-based surfaces: PCI GISOGRUND	1 bag (20 kg) + 5,4 to 6 litres of water	C2 TE S2	5,6 m <sup>2</sup>	12 hours	3 days		
SAINT-GOBAIN / WEBER	50x50; 100x40; 100x50	WEBER.COL UltraGres Evo	For gypsum-based surfaces: WEBER.PRIM PF15	1 bag (25 kg) + 6,7/7 litres of water	C2 TE S1	6 m <sup>2</sup>	8 hours	14 days		
		WEBER.COL UltraGres Top		1 bag (25 kg) + 6,7/7 litres of water	C2 TE S1					
ARDEX	All sizes	ARDEX X 77 microtec + ARDEX E 90	For gypsum-based surfaces: ARDEX P 51	1 bag (25 kg) + 1 can of ARDEX E 90 (4,5 kg) + 9 litres of water	C2 T(T) E(E) S2	10 m <sup>2</sup>	8 hours	1 day	Installation with substrate troweling of adhesive (6 mm trowel)	
 For situations in which a quick setting adhesive is recommended	MAPEI	50x50; 100x40; 100x50	GRANIRAPID	MANDATORY for gypsum-based, anhydrite or absorbent surfaces: Primer G or ECOPRIM T	Component A: 1 bag (25 kg) Component B: tub (5,5 kg)	C2 F S1	6 m <sup>2</sup>	3 hours	1 day	Installation with substrate and tile troweling of adhesive
			ULTRALITE S1 QUICK		1 bag (15 kg) + 5,1/5,7 litres of water	C2 FTE S1				
		100x100; 300x100	ULTRALITE S2 QUICK		1 bag (15 kg) + 5,1/5,7 litres of water	C2 FE S2	7 m <sup>2</sup>			
			ELASTORAPID		Component A: 1 bag (25 kg) Component B: tub (6,5 kg)	C2 FTE S2	6 m <sup>2</sup>			
	KERAKOLL	All sizes	H40 REVOLUTION	For gypsum-based surfaces: Primer A ECO	Grey 1 bag (25 kg) from 6 to 7 litres of water	C2FTE	6 m <sup>2</sup>	2 hours	1 day	
					White 1 bag (25 kg) from 6 to 7,3 litres of water					
	KERAKOLL	All sizes	H40 EXTREME	For gypsum-based surfaces: SLC ECO EP 21	1 bucket (10 kg)	R2	4 m <sup>2</sup>	4 hours	12 hours	
					LATICRETE	All sizes	LATICRETE 335 Rapid Super Flex + LATICRETE 282 Latex Additive	Not necessary, according to manufacturer	1 bag (25 kg) + 6/7 litres of latex	
	LITOKOL	50x50; 100x40; 100x50	LITOSTONE K99 + LATEXKOL + water	For gypsum-based surfaces: Primer C	1 bag (25 kg) + 3,5 litres of LATEXKOL + 3,5 litres of water	C2 FE S1	5 m <sup>2</sup>	4 hours	1 day	
			LITOSTONE K99 + LATEXKOL		1 bag (25 kg) + 7,5 kg of LATEXKOL	C2 FE S2				
PCI - BASF	All sizes	PCI FLEXMOERTEL S2 RAPID	For gypsum-based surfaces: PCI GISOGRUND	1 bag (20 kg) + 3,8 litres of water	C2 FT S2	8,3 m <sup>2</sup>	5 hours	1 day		
SAINT-GOBAIN / WEBER	All sizes	WEBER.COL UltraGres Fast	For gypsum-based surfaces: WEBER.PRIM PF15	1 bag (25 kg) + 6/6,3 litres of WEBER L50	C2 FTE S1	6 m <sup>2</sup>	3 hours	1 day		
ARDEX	All sizes	ARDEX X 77 S microtec + ARDEX E 90	For gypsum-based surfaces: ARDEX P 51	1 bag (25 kg) + 3 kg of ARDEX E 90 + 7,5 litres of water	C2 FT(T) E S2	10 m <sup>2</sup>	90 min.	6 hours	Installation with substrate troweling of adhesive (6 mm trowel)	

(\*) Instructions provided directly by manufacturers, who guarantee the information given.

For explanations or more details, contact the technical support offices of the product manufacturers (see "9 - Useful contacts").

(\*\*) Instructions provided directly by manufacturers, who guarantee the information given. If a product is offered in both "white" and a "grey" versions, the mixing ratio may vary. For explanations or more details, contact the technical support offices of the product manufacturers (see "9 - Useful contacts").



(\*\*\*) Ratings provided directly by manufacturers, who guarantee the information given, are based on laboratory tests performed at 23° C and with a relative humidity of 50%. In the event of use in different situations or for explanations or more details, contact the technical support offices of the product manufacturers (see "9 - Useful contacts").

(\*\*\*\*) Product names shown may vary according to destination countries in relation to the commercial assessment of the manufacturer.

## A.2b - Wall installation in interiors of KERLITE 3plus and KERLITE 5plus



**Substrate:** concrete, old ceramic tile, marble, stone.

At the discretion of P.S.	Supplier	Size of slabs (cm)	Product (*) (***)	Primer, if necessary (*) (***)	Mixing ratio (* *)	Class (*)	Nominal coverage (*)	Set for light foot traffic and ready for grouting times (**)	Ready for use (***)	Installation (*)
 <p>For situations in which a normal setting adhesive is recommended</p>	MAPEI	50x50; 100x40; 100x50	KERAFLEX MAXI S1	If levelling is necessary, on the mentioned supports, apply ECOPRIM GRIP beforehand	1 bag (25 kg) + 7.2/7.7 litres of water	C2 TE S1	7 m <sup>2</sup>	8 hours	14 days	Installation with substrate and tile troweling of adhesive
			ULTRALITE S1		1 bag (15 kg) + 8.4/8.7 litres of water	C2 TE S1				
		100x100; 300x100	ULTRALITE S2		1 bag (15 kg) + 5.9/6.2 litres of water	C2 E S2	6.3 m <sup>2</sup>			
			KERABOND + ISOLASTIC		1 bag (25 kg) + 8.5 kg of ISOLASTIC	C2 E S2	6.5 m <sup>2</sup>			
	KERAKOLL	All sizes	H40 NO LIMITS	KERAGRIP ECO	Grey 1 bag (25 kg) from 7.1 to 8.5 litres of water	C2 TE	6 m <sup>2</sup>	20 hours	3 days	
			H40 EXTREME		Not necessary, according to manufacturer					
	LATICRETE	All sizes	LATICRETE 254 Platinum	Not necessary, according to manufacturer	1 bag (25 kg) + 6 litres of water	C2 TE S1	5 m <sup>2</sup>	1 day	7 days	
	LITOKOL	50x50; 100x40; 100x50	SUPERFLEX K77	Not necessary, according to manufacturer	1 bag (25 kg) + 8.5 litres of water	C2 TE S1	6 m <sup>2</sup>	8 hours	7 days	
			100x100; 300x100		HYPERFLEX K100	1 bag (20 kg) + 7 litres of water	C2 TE S2			
	PCI - BASF	All sizes	PCI FLEXMOERTEL S2	For gypsum-based surfaces: PCI GISOGRUND	1 bag (20 kg) + 5.4 to 6 litres of water	C2 TE S2	5.6 m <sup>2</sup>	12 hours	3 days	
SAINT-GOBAIN / WEBER	50x50; 100x40; 100x50	WEBER.COL UltraGres Top	For old ceramic tiles, marble slabs and stone: WEBER.FLOOR 4716 Primer	1 bag (15 kg) + 6.7/7 litres of water	C2 TE S1	6 m <sup>2</sup>	8 hours	14 days		
		100x100; 300x100		WEBER.COL UltraGres Top + WEBER L50	1 bag (15 kg) + 7 litres of WEBER L50				C2 TE S2	
ARDEX	All sizes	ARDEX X 77 microtec + ARDEX E 90	For old ceramic tiles, marble slabs and stone, or alternatively: - ARDEX P 4 - ARDEX X 77 (rough levelled)	1 bag (25 kg) + 1 can of ARDEX E 90 (4.5 kg) + 9 litres of water	C2 T(T) E(E) S2	10 m <sup>2</sup>	8 hours	1 day	Installation with substrate troweling of adhesive (6 mm trowel)	
 <p>For situations in which a quick setting adhesive is recommended</p>	MAPEI	50x50; 100x40; 100x50	GRANIRAPID	If levelling is necessary, on the mentioned supports, apply ECOPRIM GRIP beforehand	Component A: 1 bag (25 kg) Component B: tub (5.5 kg)	C2 F S1	6 m <sup>2</sup>	3 hours	1 day	Installation with substrate and tile troweling of adhesive
			ULTRALITE S1 QUICK		1 bag (15 kg) + 5.1/5.7 litres of water	C2 FTE S1				
		100x100; 300x100	ULTRALITE S2 QUICK		Component A: 1 bag (25 kg) Component B: tub (6.5 kg)	C2 FTE S2	7 m <sup>2</sup>			
			ELASTORAPID		Component A: 1 bag (25 kg) Component B: tub (6.5 kg)	C2 FTE S2	6 m <sup>2</sup>			
	KERAKOLL	All sizes	H40 REVOLUTION	Not necessary, according to manufacturer	Grey 1 bag (25 kg) from 6 to 7 litres of water	C2FTE	6 m <sup>2</sup>	2 hours	1 day	
			H40 EXTREME		White 1 bag (25 kg) from 6 to 7.3 litres of water					
	LATICRETE	All sizes	LATICRETE 335 Rapid Super Flex + LATICRETE 282 Latex Additive	Not necessary, according to manufacturer	1 bag (25 kg) + 6/7 litres of latex	C2 TE F	5 m <sup>2</sup>	6 hours	2 days	
	LITOKOL	50x50; 100x40; 100x50	LITOSTONE K99 + LATEXKOL + water	Not necessary, according to manufacturer	1 bag (25 kg) + 3.5 litres of LATEXKOL + 3.5 litres of water	C2 FE S1	5 m <sup>2</sup>	4 hours	1 day	
			100x100; 300x100		LITOSTONE K99 + LATEXKOL					
	PCI - BASF	All sizes	PCI FLEXMOERTEL S2 RAPID	For gypsum-based surfaces: PCI GISOGRUND	1 bag (20 kg) + 3.8 litres of water	C2 FT S2	8.3 m <sup>2</sup>	5 hours	1 day	
SAINT-GOBAIN / WEBER	All sizes	WEBER.COL UltraGres Fast	For old ceramic tiles, marble slabs and stone: WEBER.FLOOR 4716 Primer	1 bag (25 kg) + 6/6.3 litres of water	C2 FTE S1	6 m <sup>2</sup>	3 hours	1 day		
ARDEX	All sizes	ARDEX X 77 S microtec + ARDEX E 90	For old ceramic tiles, marble slabs and stone, or alternatively: - ARDEX P 4 - ARDEX X 77 (rough levelled)	1 bag (25 kg) + 3 kg ARDEX E 90 + 7.5 litres of water	C2 FT(T) E S2	10 m <sup>2</sup>	90 min.	6 hours	Installation with substrate troweling of adhesive (6 mm trowel)	

(\*) Instructions provided directly by manufacturers, who guarantee the information given.

For explanations or more details, contact the technical support offices of the product manufacturers (see "9 - Useful contacts").

(\*\*) Instructions provided directly by manufacturers, who guarantee the information given. If a product is offered in both "white" and a "grey" versions, the mixing ratio may vary. For explanations or more details, contact the technical support offices of the product manufacturers (see "9 - Useful contacts").



(\*\*\*) Ratings provided directly by manufacturers, who guarantee the information given, are based on laboratory tests performed at 23° C and with a relative humidity of 50%. In the event of use in different situations or for explanations or more details, contact the technical support offices of the product manufacturers (see "9 - Useful contacts").



## A.2c - Wall installation in interiors of KERLITE 3plus and KERLITE 5plus



**Substrate:** particle board, metal.

At the discretion of P.S.	Supplier	Size of slabs (cm)	Product (*) (****)	Primer, if necessary (*) (****)	Mixing ratio (* *)	Class (*)	Nominal coverage (*)	Set for light foot traffic and ready for grouting times (**)	Ready for use (***)	Installation (*)
 <b>For situations in which a normal setting adhesive is recommended</b>	MAPEI	All sizes	ULTRABOND ECO PU 2K	Not necessary, according to manufacturer	1 bucket (10 kg)	R2T	3 m <sup>2</sup>	12 hours	7 days	Installation with substrate troweling of adhesive (6 mm trowel)
			KERALASTIC			R2				
			KERALASTIC T			R2T				
	KERAKOLL	All sizes	SUPERFLEX ECO	Not necessary, according to manufacturer	1 bucket (8 kg)	R2T	3 m <sup>2</sup>	12 hours	3 days	Installation with substrate and tile troweling of adhesive
			H40 NO LIMITS	KERAGRIP ECO	Grey 1 bag (25 kg) from 7.1 to 8.5 litres of water	C2 TE	6 m <sup>2</sup>	20 hours	3 days	
	White 1 bag (25 kg) from 7.2 to 9.5 litres of water									
	KERAKOLL	All sizes	H40 EXTREME	Not necessary, according to manufacturer	1 bucket (10 kg)	R2	4 m <sup>2</sup>	4 hours	12 hours	
			LATICRETE	All sizes	LATALASTIK	Not necessary, according to manufacturer	1 bucket of component A (5 kg) 1 bucket of component B (2 kg)	R2T	3 m <sup>2</sup>	
LITOKOL	All sizes	LITOELASTIC	Not necessary, according to manufacturer	1 bucket (10 kg)	R2T	3 m <sup>2</sup>	12 hours	5 days		
PCI - BASF	All sizes	PCI FLEXMOERTEL S2	For gypsum-based surfaces: PCI GISOGRUND	1 bag (20 kg) + 5.4 to 6 litres of water	C2 TE S2	5.6 m <sup>2</sup>	12 hours	3 days		
SAINT-GOBAIN / WEBER	All sizes	WEBER.COL. FIX CR	Not necessary, according to manufacturer	1 bucket (10 kg)	R2 T	3 m <sup>2</sup>	12 hours	2 days		
ARDEX	All sizes	ARDEX X 77 microtec + ARDEX E 90	ARDEX P 82	1 bag (25 kg) + 1 can of ARDEX E 90 (4.5 kg) + 9 litres of water	C2 T(T) E(E) S2	10 m <sup>2</sup>	8 hours	1 day	Installation with substrate troweling of adhesive (6 mm trowel)	
 <b>For situations in which a quick setting adhesive is recommended</b>	MAPEI	All sizes	KERAQUICK + LATEX PLUS	Not necessary, according to manufacturer	1 bag (25 kg) + 8.5 kg of LATEX PLUS	C2 FT S2	7 m <sup>2</sup>	3 hours	1 day	Installation with substrate troweling of adhesive (6 mm trowel)
	KERAKOLL	All sizes	H40 REVOLUTION	KERAGRIP ECO	Grey 1 bag (25 kg) from 6 to 7 litres of water	C2FTE	6 m <sup>2</sup>	2 hours	1 day	Installation with substrate and tile troweling of adhesive
			White 1 bag (25 kg) from 6 to 7.3 litres of water							
	KERAKOLL	All sizes	H40 EXTREME	Not necessary, according to manufacturer	1 bucket (10 kg)	R2	4 m <sup>2</sup>	4 hours	12 hours	
			LATICRETE	All sizes	LATALASTIK	Not necessary, according to manufacturer	1 bucket of component A (5 kg) 1 bucket of component B (2 kg)	R2T	3 m <sup>2</sup>	
	LITOKOL	All sizes	LITOELASTIC	Not necessary, according to manufacturer	1 bucket (10 kg)	R2T	3 m <sup>2</sup>	12 hours	5 days	
	PCI - BASF	All sizes	PCI FLEXMOERTEL S2 RAPID	For gypsum-based surfaces: PCI GISOGRUND	1 bag (20 kg) + 3.8 litres of water	C2 FT S2	8.3 m <sup>2</sup>	5 hours	1 day	
	SAINT-GOBAIN / WEBER	All sizes	WEBER.COL. FIX CR	Not necessary, according to manufacturer	1 bucket (10 kg)	R2 T	3 m <sup>2</sup>	12 hours	2 days	
ARDEX	All sizes	ARDEX X 77 S microtec + ARDEX E 90	ARDEX P 82	1 bag (25 kg) + 3 kg ARDEX E 90 + 7.5 litres of water	C2 F(F)T E S2	10 m <sup>2</sup>	90 min.	6 hours	Installation with substrate troweling of adhesive (6 mm trowel)	

(\*) Instructions provided directly by manufacturers, who guarantee the information given.

For explanations or more details, contact the technical support offices of the product manufacturers (see "9 - Useful contacts").

(\*\*) Instructions provided directly by manufacturers, who guarantee the information given. If a product is offered in both "white" and a "grey" versions, the mixing ratio may vary. For explanations or more details, contact the technical support offices of the product manufacturers (see "9 - Useful contacts").



(\*\*\*) Ratings provided directly by manufacturers, who guarantee the information given, are based on laboratory tests performed at 23° C and with a relative humidity of 50%. In the event of use in different situations or for explanations or more details, contact the technical support offices of the product manufacturers (see "9 - Useful contacts").

(\*\*\*\*) Product names shown may vary according to destination countries in relation to the commercial assessment of the manufacturer.

## A.3a - Wall installation in exteriors of KERLITE 3mm



Substrate: plaster.

At the discretion of P.S.	Supplier	Size of slabs (cm)	Product (*) (****)	Primer, if necessary (*) (****)	Mixing ratio (* *)	Class (*)	Nominal coverage (*)	Set for light foot traffic and ready for grouting times (**)	Ready for use (***)	Installation (*)
 <p>For situations in which a normal setting adhesive is recommended</p>	MAPEI	50x50; 100x40; 100x50	KERAFLEX MAXI S1	Not necessary, according to manufacturer	1 bag (25 kg) + 7.2/7.7 litres of water	C2 TE S1	7 m <sup>2</sup>	8 hours	14 days	Installation with substrate and tile troweling of adhesive
			ULTRALITE S1		1 bag (15 kg) + 8.4/8.7 litres of water	C2 TE S1				
		100x100	ULTRALITE S2		1 bag (15 kg) + 5.9/6.2 litres of water	C2 E S2	6.3 m <sup>2</sup>			
			KERABOND + ISOLASTIC		1 bag (25 kg) + 8.5 kg of ISOLASTIC	C2 E S2	6.5 m <sup>2</sup>			
	KERAKOLL	50x50; 100x40; 100x50; 100x100	H40 NO LIMITS	Not necessary, according to manufacturer	Grey 1 bag (25 kg) from 7,1 to 8,5 litres of water White 1 bag (25 kg) from 7.2 to 9.5 litres of water	C2 TE	6 m <sup>2</sup>	20 hours	3 days	
	LATICRETE	50x50; 100x40; 100x50; 100x100	LATICRETE 254 Platinum	Not necessary, according to manufacturer	1 bag (25 kg) + 6 litres of water	C2 TE S1	5 m <sup>2</sup>	1 day	7 days	
	LITOKOL	50x50; 100x40; 100x50	SUPERFLEX K77	Not necessary, according to manufacturer	1 bag (25 kg) + 8.5 litres of water	C2 TE S1	6 m <sup>2</sup>	8 hours	7 days	
			100x100		HYPERFLEX K100	1 bag (20 kg) + 7 litres of water	C2 TE S2			
	PCI - BASF	All sizes	PCI FLEXMOERTEL S1	For gypsum-based surfaces: PCI GISOGRUND	1 bag (20 kg) + 7.4 litres of water	C2 TE S1	7.1 m <sup>2</sup>	12 hours	3 days	
	SAINT-GOBAIN / WEBER	50x50; 100x40; 100x50	WEBER.COL UltraGres Top	Not necessary, according to manufacturer	1 bag (25 kg) + 6.7/7 litres of water	C2 TE S1	6 m <sup>2</sup>	8 hours	14 days	
100x100		WEBER.COL UltraGres Top + WEBER L50	Not necessary, according to manufacturer	1 bag (25 kg) + 6.7/7 litres of WEBER L50	C2 TE S2					
ARDEX	50x50; 100x40; 100x50; 100x100	ARDEX X 77 microtec	Not necessary, according to manufacturer	1 bag (25 kg) + 11 litres of water	C2 T(T) E(E) S1	10 m <sup>2</sup>	8 hours	1 day		
 <p>For situations in which a quick setting adhesive is recommended</p>	MAPEI	50x50; 100x40; 100x50	ELASTORAPID	Not necessary, according to manufacturer	Component A: 1 bag (25 kg) Component B: tub (6.5 kg)	C2 FTE S2	6 m <sup>2</sup>	3 hours	1 day	Installation with substrate and tile troweling of adhesive
			ULTRALITE S1 QUICK		1 bag (15 kg) + 5.1/5.7 litres of water	C2 FTE S1				
		100x100	ULTRALITE S2 QUICK		1 bag (25 kg) + 8.5 kg of LATEX PLUS	C2 FT S2	7 m <sup>2</sup>			
			KERAQUICK + LATEX PLUS			5 m <sup>2</sup>				
	KERAKOLL	50x50; 100x40; 100x50; 100x100	H40 REVOLUTION	Not necessary, according to manufacturer	Grey 1 bag (25 kg) from 6 to 7 litres of water White 1 bag (25 kg) from 6 to 7.3 litres of water	C2 FTE	6 m <sup>2</sup>	2 hours	1 day	
	LATICRETE	50x50; 100x40; 100x50; 100x100	LATICRETE 335 Rapid Super Flex + LATICRETE 282 Latex Additive	Not necessary, according to manufacturer	1 bag (25 kg) + 6/7 litres of latex	C2 TE F	5 m <sup>2</sup>	6 hours	2 days	
	LITOKOL	50x50; 100x40; 100x50	LITOSTONE K99 + LATEXKOL + water	Not necessary, according to manufacturer	1 bag (25 kg) + 3.5 litres of LATEXKOL + 3.5 litres of water	C2 FE S1	5 m <sup>2</sup>	4 hours	1 day	
			100x100		LITOSTONE K99 + LATEXKOL	1 bag (25 kg) + 7.5 kg of LATEXKOL				
	PCI - BASF	All sizes	PCI FLEXMOERTEL S1 RAPID	For gypsum-based surfaces: PCI GISOGRUND	1 bag (20 kg) + 9 litres of water	C2 FT S1	6.5 m <sup>2</sup>	3 hours	1 day	
	SAINT-GOBAIN / WEBER	50x50; 100x40; 100x50	WEBER.COL UltraGres Fast + WEBER L50	Not necessary, according to manufacturer	1 bag (25 kg) + 6/6,3 litres of WEBER L50	C2 FTE S1	6 m <sup>2</sup>	3 hours	1 day	
100x100		WEBER.COL UltraGres Fast + WEBER L50	1 bag (25 kg) + 6/6,3 litres of WEBER L50		C2 FTE S2					
ARDEX	50x50; 100x40; 100x50; 100x100	ARDEX X 77 S microtec	Not necessary, according to manufacturer	1 bag (25 kg) + 8.5 litres of water	C2 FT(T) E S1	10 m <sup>2</sup>	90 min.	6 hours		

(\*) Instructions provided directly by manufacturers, who guarantee the information given.

For explanations or more details, contact the technical support offices of the product manufacturers (see "9 - Useful contacts").

(\*\*) Instructions provided directly by manufacturers, who guarantee the information given. If a product is offered in both "white" and a "grey" versions, the mixing ratio may vary. For explanations or more details, contact the technical support offices of the product manufacturers (see "9 - Useful contacts").



(\*\*\*) Ratings provided directly by manufacturers, who guarantee the information given, are based on laboratory tests performed at 23° C and with a relative humidity of 50%. In the event of use in different situations or for explanations or more details, contact the technical support offices of the product manufacturers (see "9 - Useful contacts").

40 (\*\*\*\*) Product names shown may vary according to destination countries in relation to the commercial assessment of the manufacturer.

## A.3b - Wall installation in exteriors of KERLITE 3mm



Substrate: concrete

At the discretion of P.S.	Supplier	Size of slabs (cm)	Product (*) (****)	Primer, if necessary (*) (****)	Mixing ratio (* *)	Class (*)	Nominal coverage (*)	Set for light foot traffic and ready for grouting times (**)	Ready for use (***)	Installation (*)
 For situations in which a normal setting adhesive is recommended	MAPEI	50x50; 100x40; 100x50	KERAFLEX MAXI S1	Not necessary, according to manufacturer	1 bag (25 kg) + 7.2/7.7 litres of water	C2 TE S1	7 m <sup>2</sup>	8 hours	14 days	Installation with substrate and tile troweling of adhesive
			ULTRALITE S1		1 bag (15 kg) + 8.4/8.7 litres of water	C2 TE S1				
		100x100	ULTRALITE S2		1 bag (15 kg) + 5.9/6.2 litres of water	C2 E S2	6.3 m <sup>2</sup>			
			KERABOND + ISOLASTIC		1 bag (25 kg) + 8.5 kg of ISOLASTIC	C2 E S2	6.5 m <sup>2</sup>			
	KERAKOLL	50x50; 100x40; 100x50; 100x100	H40 NO LIMITS	Not necessary, according to manufacturer	Grey 1 bag (25 kg) from 7.1 to 8.5 litres of water White 1 bag (25 kg) from 7.2 to 9.5 litres of water	C2 TE	6 m <sup>2</sup>	20 hours	3 days	
	LATICRETE	All sizes	LATICRETE 254 Platinum	Not necessary, according to manufacturer	1 bag (25 kg) + 6 litres of water	C2 TE S1	5 m <sup>2</sup>	1 day	7 days	
	LITOKOL	50x50; 100x40; 100x50	SUPERFLEX K77	Not necessary, according to manufacturer	1 bag (25 kg) + 8.5 litres of water	C2 TE S1	6 m <sup>2</sup>	8 hours	7 days	
		100x100	HYPERFLEX K100		1 bag (20 kg) + 7 litres of water	C2 TE S2	6 m <sup>2</sup>			
	PCI - BASF	All sizes	PCI FLEXMOERTEL S1	For gypsum-based surfaces: PCI GISOGRUND	1 bag (20 kg) + 7.4 litres of water	C2 TE S1	7.1 m <sup>2</sup>	12 hours	3 days	
	SAINT-GOBAIN / WEBER	50x50; 100x40; 100x50	WEBER.COL UltraGres Top	Not necessary, according to manufacturer	1 bag (25 kg) + 6.7/7 litres of water	C2 TE S1	6 m <sup>2</sup>	8 hours	14 days	
100x100		WEBER.COL UltraGres Top + WEBER L50	Not necessary, according to manufacturer	1 bag (25 kg) + 7 litres of WEBER L50	C2 TE S2					
ARDEX	50x50; 100x40; 100x50; 100x100	ARDEX X 77 microtec	Not necessary, according to manufacturer	1 bag (25 kg) + 11 litres of water	C2 T(T) E(E) S1	10 m <sup>2</sup>	8 hours	1 day		
 For situations in which a quick setting adhesive is recommended	MAPEI	50x50; 100x40; 100x50	ELASTORAPID	Not necessary, according to manufacturer	Component A: 1 bag (25 kg) Component B: tub (6.5 kg)	C2 FTE S2	6 m <sup>2</sup>	3 hours	1 day	Installation with substrate and tile troweling of adhesive
			ULTRALITE S1 QUICK		1 bag (15 kg) + 5.1/5.7 litres of water	C2 FTE S1				
		100x100	ULTRALITE S2 QUICK		1 bag (15 kg) + 5.1/5.7 litres of water	C2 FE S2	7 m <sup>2</sup>			
			KERAQUICK + LATEX PLUS		1 bag (25 kg) + 8.5 kg of LATEX PLUS	C2 FT S2	5 m <sup>2</sup>			
	KERAKOLL	50x50; 100x40; 100x50; 100x100	H40 REVOLUTION	Not necessary, according to manufacturer	Grey 1 bag (25 kg) from 6 to 7 litres of water White 1 bag (25 kg) from 6 to 7.3 litres of water	C2 FTE	6 m <sup>2</sup>	2 hours	1 day	
	LATICRETE	All sizes	LATICRETE 335 Rapid Super Flex + LATICRETE 282 Latex Additive	Not necessary, according to manufacturer	1 bag (25 kg) + 6/7 litres of latex	C2 TE F	5 m <sup>2</sup>	6 hours	2 days	
	LITOKOL	50x50; 100x40; 100x50	LITOSTONE K99 + LATEXKOL + water	Not necessary, according to manufacturer	1 bag (25 kg) + 3.5 litres of LATEXKOL + 3.5 litres of water	C2 FE S1	5 m <sup>2</sup>	4 hours	1 day	
		100x100	LITOSTONE K99 + LATEXKOL		1 bag (25 kg) + 7.5 kg of LATEXKOL	C2 FE S2				
	PCI - BASF	All sizes	PCI FLEXMOERTEL S1 RAPID	For gypsum-based surfaces: PCI GISOGRUND	1 bag (20 kg) + 9 litres of water	C2 FT S1	6.5 m <sup>2</sup>	3 hours	1 day	
	SAINT-GOBAIN / WEBER	50x50; 100x40; 100x50	WEBER.COL UltraGres Fast + WEBER L50	Not necessary, according to manufacturer	1 bag (25 kg) + 6/6,3 litres of WEBER L50	C2 FTE S1	6 m <sup>2</sup>	3 hours	1 day	
100x100		WEBER.COL UltraGres Fast + WEBER L50	1 bag (25 kg) + 6/6,3 litres of WEBER L50		C2 FTE S2					
ARDEX	50x50; 100x40; 100x50; 100x100	ARDEX X 77 S microtec	Not necessary, according to manufacturer	1 bag (25 kg) + 8.5 litres of water	C2 FT(T) E S1	10 m <sup>2</sup>	90 min.	6 hours		

(\*) Instructions provided directly by manufacturers, who guarantee the information given.

For explanations or more details, contact the technical support offices of the product manufacturers (see "9 - Useful contacts").

(\*\*) Instructions provided directly by manufacturers, who guarantee the information given. If a product is offered in both "white" and a "grey" versions, the mixing ratio may vary. For explanations or more details, contact the technical support offices of the product manufacturers (see "9 - Useful contacts").



(\*\*\*) Ratings provided directly by manufacturers, who guarantee the information given, are based on laboratory tests performed at 23° C and with a relative humidity of 50%. In the event of use in different situations or for explanations or more details, contact the technical support offices of the product manufacturers (see "9 - Useful contacts").

(\*\*\*\*) Product names shown may vary according to destination countries in relation to the commercial assessment of the manufacturer.

## A.4a - Wall installation in exteriors of KERLITE 3plus and KERLITE 5plus



Substrate: plaster.

At the discretion of P.S.	Supplier	Size of slabs (cm)	Product (*) (****)	Primer, if necessary (*) (****)	Mixing ratio (* *)	Class (*)	Nominal coverage (*)	Set for light foot traffic and ready for grouting times (**)	Ready for use (***)	Installation (*)
 <p>For situations in which a normal setting adhesive is recommended</p>	MAPEI	50x50; 100x40; 100x50	KERABOND + ISOLASTIC	Not necessary, according to manufacturer	1 bag (25 kg) + 8.5 kg of ISOLASTIC	C2 E S2	5 m <sup>2</sup>	8 hours	14 days	Installation with substrate and tile troweling of adhesive
			ULTRALITE S2		1 bag (15 kg) + 5.9/6.2 litres of water	C2 E S2	3 m <sup>2</sup>			
		100x100; 300x100	KERALASTIC T		1 bucket (10 kg)	R2T	2,5 m <sup>2</sup>	12 hours	7 days	
	KERAKOLL	All sizes	H40 NO LIMITS	Not necessary, according to manufacturer	Grey 1 bag (25 kg) from 7.1 to 8.5 litres of water	C2 TE	6 m <sup>2</sup>	20 hours	3 days	
					White 1 bag (25 kg) from 7.2 to 9.5 litres of water					
	KERAKOLL	All sizes	H40 EXTREME	Not necessary, according to manufacturer	1 bucket (10 kg)	R2	4 m <sup>2</sup>	4 hours	12 hours	
					LATICRETE	All sizes	LATICRETE 254 Platinum	Not necessary, according to manufacturer	1 bag (25 kg) + 6 litres of water	
	LITOKOL	All sizes	HYPERFLEX K100	Not necessary, according to manufacturer	1 bag (20 kg) + 7 litres of water	C2 TE S2	6 m <sup>2</sup>	8 hours	7 days	
	PCI - BASF	All sizes	PCI FLEXMOERTEL S2	For gypsum-based surfaces: PCI GISOGRUND	1 bag (20 kg) + 5.4 to 6 litres of water	C2 TE S2	5.6 m <sup>2</sup>	12 hours	3 days	
	SAINT-GOBAIN / WEBER	50x50; 100x40; 100x50	WEBER.COL UltraGres Top + WEBER L50	Not necessary, according to manufacturer	1 bag (15 kg) + 7 litres of WEBER L50	C2 TE S2	6 m <sup>2</sup>	8 hours	14 days	
100x100; 300x100		WEBER.COL Fix CR	Not necessary, according to manufacturer	1 bucket (10 kg)	R2T	3 m <sup>2</sup>	12 hours	2 days		
ARDEX	All sizes	ARDEX X 77 microtec + ARDEX E 90	Not necessary, according to manufacturer	1 bag (25 kg) + 1 can of ARDEX E 90 (4.5 kg) + 9 litres of water	C2 T(T) E(E) S2	10 m <sup>2</sup>	8 hours	1 day		
 <p>For situations in which a quick setting adhesive is recommended</p>	MAPEI	50x50; 100x40; 100x50	ULTRALITE S2 QUICK	Not necessary, according to manufacturer	1 bag (15 kg) + 6 litres of water	C2 FE S2	4 m <sup>2</sup>	3 hours	2 days	
			ELASTORAPID		Component A: 1 bag (25 kg) Component B: tub (6.5 kg)	C2 FTES2			5 m <sup>2</sup>	1 day
		100x100; 300x100	KERAQUICK + LATEX PLUS		1 bag (25 kg) + 8.5 kg of LATEX PLUS	C2 FT S2				
	KERAKOLL	All sizes	H40 REVOLUTION	Not necessary, according to manufacturer	Grey 1 bag (25 kg) from 6 to 7 litres of water	C2 FTE	6 m <sup>2</sup>	2 hours	1 day	
					White 1 bag (25 kg) from 6 to 7.3 litres of water					
	KERAKOLL	All sizes	H40 EXTREME	Not necessary, according to manufacturer	1 bucket (10 kg)	R2	4 m <sup>2</sup>	4 hours	12 hours	
					LATICRETE	All sizes	LATICRETE 335 Rapid Super Flex + LATICRETE 282 Latex Additive	Not necessary, according to manufacturer	1 bag (25 kg) + 6/7 litres of latex	C2 TE F
	LITOKOL	All sizes	LITOSTONE K99 + LATEXKOL	Not necessary, according to manufacturer	1 bag (25 kg) + 7.5 kg of LATEXKOL	C2 FE S2	5 m <sup>2</sup>	4 hours	1 day	
	PCI - BASF	All sizes	PCI FLEXMOERTEL S2 RAPID	For gypsum-based surfaces: PCI GISOGRUND	1 bag (20 kg) + 3.8 litres of water	C2 FT S2	8.3 m <sup>2</sup>	5 hours	1 day	
	SAINT-GOBAIN / WEBER	50x50	WEBER.COL UltraGres Fast	Not necessary, according to manufacturer	1 bag (25 kg) + 6/6.3 litres of water	C2 FTE S1	6 m <sup>2</sup>	3 hours	1 day	
100x40; 100x50		WEBER.COL UltraGres Fast + WEBER L50	1 bag (25 kg) + 6/6.3 litres WEBER L50		C2 FTE S2	6 m <sup>2</sup>	3 hours	1 day		
100x100; 300x100		WEBER.COL Fix CR	1 bucket (10 kg)		R2T	3 m <sup>2</sup>	12 hours	2 days		
ARDEX	All sizes	ARDEX X 77 S microtec + ARDEX E 90	Not necessary, according to manufacturer	1 bag (25 kg) + 3 kg of ARDEX E 90 + 7.5 litres of water	C2 FT(T) E S2	10 m <sup>2</sup>	90 min.	6 hours		

(\*) Instructions provided directly by manufacturers, who guarantee the information given.

For explanations or more details, contact the technical support offices of the product manufacturers (see "9 - Useful contacts").

(\*\*) Instructions provided directly by manufacturers, who guarantee the information given. If a product is offered in both "white" and a "grey" versions, the mixing ratio may vary. For explanations or more details, contact the technical support offices of the product manufacturers (see "9 - Useful contacts").

(\*\*\*) Ratings provided directly by manufacturers, who guarantee the information given, are based on laboratory tests performed at 23° C and with a relative humidity of 50%. In the event of use in different situations or for explanations or more details, contact the technical support offices of the product manufacturers (see "9 - Useful contacts").

42 (\*\*\*\*) Product names shown may vary according to destination countries in relation to the commercial assessment of the manufacturer.

## A.4b - Wall installation in exteriors of KERLITE 3plus and KERLITE 5plus



Substrate: concrete

At the discretion of P.S.	Supplier	Size of slabs (cm)	Product (*) (****)	Primer, if necessary (*) (****)	Mixing ratio (* *)	Class (*)	Nominal coverage (*)	Set for light foot traffic and ready for grouting times (**)	Ready for use (***)	Installation (*)
<p>For situations in which a normal setting adhesive is recommended</p>	MAPEI	50x50; 100x40; 100x50	KERABOND + ISOLASTIC	Not necessary, according to manufacturer	1 bag (25 kg) + 8.5 kg of ISOLASTIC	C2 E S2	5 m <sup>2</sup>	8 hours	14 days	Installation with substrate and tile troweling of adhesive
			ULTRALITE S2		1 bag (15 kg) + 5.9/6.2 litres of water	C2 E S2	3 m <sup>2</sup>			
		100x100; 300x100	KERALASTIC T		1 bucket (10 kg)	R2T	2.5 m <sup>2</sup>	12 hours	7 days	
	KERAKOLL	All sizes	H40 NO LIMITS	Not necessary, according to manufacturer	Grey 1 bag (25 kg) from 7.1 to 8.5 litres of water	C2 TE	6 m <sup>2</sup>	20 hours	3 days	
					White 1 bag (25 kg) from 7.2 to 9.5 litres of water					
	ARDEX	All sizes	ARDEX X 77 microtec + ARDEX E 90	Not necessary, according to manufacturer	1 bucket (10 kg)	R2	4 m <sup>2</sup>	4 hours	12 hours	
					LATICRETE	All sizes	LATICRETE 254 Platinum	Not necessary, according to manufacturer	1 bag (25 kg) + 6 litres of water	
	LITOKOL	All sizes	HYPERFLEX K100	Not necessary, according to manufacturer	1 bag (20 kg) + 7 litres of water	C2 TE S2	6 m <sup>2</sup>	8 hours	7 days	
	PCI - BASF	All sizes	PCI FLEXMOERTEL S2	For gypsum-based surfaces: PCI GISOGRUND	1 bag (20 kg) + 5.4 to 6 litres of water	C2 TE S2	5.6 m <sup>2</sup>	12 hours	3 days	
	SAINT-GOBAIN / WEBER	50x50; 100x40; 100x50	WEBER.COL UltraGres Top + WEBER L50	Not necessary, according to manufacturer	1 bag (15 kg) + 7 litres of WEBER L50	C2 TE S2	6 m <sup>2</sup>	8 hours	14 days	
100x100; 300x100		WEBER.COL Fix CR	Not necessary, according to manufacturer	1 bucket (10 kg)	R2T	3 m <sup>2</sup>	12 hours	2 days		
<p>For situations in which a quick setting adhesive is recommended</p>	MAPEI	50x50; 100x40; 100x50	ULTRALITE S2 QUICK	Not necessary, according to manufacturer	1 bag (15 kg) + 6 litres of water	C2 FE S2	4 m <sup>2</sup>	3 hours	2 days	
			ELASTORAPID		Component A: 1 bag (25 kg) Component B: tub (6.5 kg)	C2 FTE S2			1 day	
		100x100; 300x100	KERAQUICK + LATEX PLUS		1 bag (25 kg) + 8.5 kg of LATEX PLUS	C2 FT S2	5 m <sup>2</sup>			
	KERAKOLL	All sizes	H40 REVOLUTION	Not necessary, according to manufacturer	Grey 1 bag (25 kg) from 6 to 7 litres of water	C2 FTE	6 m <sup>2</sup>	2 hours	1 day	
					White 1 bag (25 kg) from 6 to 7.3 litres of water					
	ARDEX	All sizes	ARDEX X 77 S microtec + ARDEX E 90	Not necessary, according to manufacturer	1 bucket (10 kg)	R2	4 m <sup>2</sup>	4 hours	12 hours	
					LATICRETE	All sizes	LATICRETE 335 Rapid Super Flex + LATICRETE 282 Latex Additive	Not necessary, according to manufacturer	1 bag (25 kg) + 6/7 litres of latex	C2 TE F
	LITOKOL	All sizes	LITOSTONE K99 + LATEXKOL	Not necessary, according to manufacturer	1 bag (25 kg) + 7.5 kg of LATEXKOL	C2 FE S2	5 m <sup>2</sup>	4 hours	1 day	
	PCI - BASF	All sizes	PCI FLEXMOERTEL S2 RAPID	For gypsum-based surfaces: PCI GISOGRUND	1 bag (20 kg) + 3.8 litres of water	C2 FT S2	8.3 m <sup>2</sup>	5 hours	1 day	
	SAINT-GOBAIN / WEBER	50x50	WEBER.COL UltraGres Fast	Not necessary, according to manufacturer	1 bag (25 kg) + 6/6.3 litres of water	C2 FTE S1	6 m <sup>2</sup>	3 hours	1 day	
100x40; 100x50		WEBER.COL UltraGres Fast + WEBER L50	1 bag (25 kg) + 6/6.3 litres WEBER L50		C2 FTE S2	6 m <sup>2</sup>	3 hours	1 day		
100x100; 300x100		WEBER.COL Fix CR	1 bucket (10 kg)		R2T	3 m <sup>2</sup>	12 hours	2 days		
ARDEX	All sizes	ARDEX X 77 S microtec + ARDEX E 90	Not necessary, according to manufacturer	1 bag (25 kg) + 3 kg ARDEX E 90 + 7.5 litres of water	C2 FT(T) E S2	10 m <sup>2</sup>	90 min.	6 hours	Installation with substrate and tile troweling of adhesive	

(\*) Instructions provided directly by manufacturers, who guarantee the information given.

For explanations or more details, contact the technical support offices of the product manufacturers (see "9 - Useful contacts").



(\*\*) Instructions provided directly by manufacturers, who guarantee the information given. If a product is offered in both "white" and a "grey" versions, the mixing ratio may vary. For explanations or more details, contact the technical support offices of the product manufacturers (see "9 - Useful contacts").

(\*\*\*\*) Ratings provided directly by manufacturers, who guarantee the information given, are based on laboratory tests performed at 23° C and with a relative humidity of 50%. In the event of use in different situations or for explanations or more details, contact the technical support offices of the product manufacturers (see "9 - Useful contacts").

(\*\*\*\*\*) Product names shown may vary according to destination countries in relation to the commercial assessment of the manufacturer.



**Substrate:** cement-based screeds, calcium sulphate-based or heated screeds, self-levelling products, concrete, old ceramic tiles, marble slabs, stone

At the discretion of P.S.	Supplier	Size of slabs (cm)	Product (*) (****)	Primer, if necessary (*) (****)	Mixing ratio (* *)	Class (*)	Nominal coverage (*)	Set for light foot traffic and ready for grouting times (**)	Ready for use (***)	Installation (*)
 <p>For situations in which a normal setting adhesive is recommended</p>	MAPEI	50x50;100x40; 100x50	KERAFLEX MAXI S1	MANDATORY for gypsum-based, anhydrite or absorbent surfaces: Primer G or ECOPRIM T For non-absorbent supports: ECOPRIM GRIP	1 bag (25 kg) + 7.2/7.7 litres of water	C2 TE S1	3.5 m <sup>2</sup>	1 day	14 days	Installation with substrate and tile troweling of adhesive
			ULTRALITE S1		1 bag (15 kg) + 8.4/8.7 litres of water	C2 TE S1		8 hours		
		100x100; 300x100	ULTRALITE S2		1 bag (15 kg) + 5.9/6.2 litres of water	C2 E S2	5 m <sup>2</sup>	1 day		
			KERABOND + ISOLASTIC		1 bag (25 kg) + 8.5 kg of ISOLASTIC	C2 E S2				
		For heated screeds: all sizes	KERABOND + ISOLASTIC		1 bag (25 kg) + 8.5 kg of ISOLASTIC	C2 E S2	3.5 m <sup>2</sup>			
			ULTRALITE S2		1 bag (15 kg) + 5.9/6.2 litres of water	C2 E S2				
	KERAKOLL	All sizes	H40 NO LIMITS	For gypsum-based surfaces: Primer A ECO	Grey 1 bag (25 kg) from 7.1 to 8.5 litres of water	C2 TE	6 m <sup>2</sup>	20 hours	3 days	
					White 1 bag (25 kg) from 7.2 to 9.5 litres of water					
			H40 EXTREME	For gypsum-based surfaces: SLC ECO EP 21	1 bucket (10 kg)	R2	4 m <sup>2</sup>	4 hours	12 hours	
	LATICRETE	All sizes	LATICRETE 254 Platinum	Not necessary, according to manufacturer	1 bag (25 kg) + 6 litres of water	C2 TE S1	5 m <sup>2</sup>	1 day	7 days	
	LITOKOL	50x50; 100x40; 100x50	SUPERFLEX K77	For anhydrite screeds: Primer C	1 bag (25 kg) + 8.5 litres of water	C2 TE S1	5 m <sup>2</sup>	8 hours	7 days	
			HYPERFLEX K100		1 bag (20 kg) + 7 litres of water	C2 TE S2	6 m <sup>2</sup>			
PCI - BASF	All sizes	PCI FLEXMOERTEL S2	For gypsum-based surfaces: PCI GISOGRUND	1 bag (20 kg) + 5.4 to 6 litres of water	C2 TE S2	5.6 m <sup>2</sup>	12 hours	3 days		
SAINT-GOBAIN / WEBER	50x50; 100x40; 100x50	WEBER.COL UltraGres Top	For gypsum-based surfaces: WEBER PRIM PF15. For old ceramic tiles, marble slabs and stone: WEBER.FLOOR 4716 Primer	1 bag (25 kg) + 6.7/7 litres of water	C2TES1	6 m <sup>2</sup>	8 hours	14 days		
				1 bag (25 kg) + 6.7/7 litres of WEBER L50	C2TES2					
	For heated screeds: all sizes	WEBER.COL PRO HF LIGHT		1 bag (25 kg) + 6.7/7 litres of WEBER L50						
ARDEX	All sizes	ARDEX X S 28 New Microtec	For gypsum- and anhydrite-based, absorbent or polished surfaces: ARDEX P 51	1 bag (25 kg) + 7.5 to 9 litres of water	C2 FTE S1	6 m <sup>2</sup>	4 hours	1 day	Installation with substrate troweling of adhesive (trowel with 12 mm tilted teeth or ARDEX Microtec trowel)	
 <p>For situations in which a quick setting adhesive is recommended</p>	MAPEI	50x50; 100x40; 100x50	GRANIRAPID	MANDATORY for gypsum-based, anhydrite or absorbent surfaces: Primer G or ECOPRIM T For non-absorbent supports: ECOPRIM GRIP	Component A: 1 bag (25 kg) Component B: tub (5.5 kg)	C2 F S1	4 m <sup>2</sup>	3 hours	1 day	
			ULTRALITE S1 QUICK		1 bag (15 kg) + 5.1/5.7 litres of water	C2 FTE S1	3.5 m <sup>2</sup>			
		100x100; 300x100	ULTRALITE S2 QUICK		1 bag (15 kg) + 5.1/5.7 litres of water	C2 FE S2	4 m <sup>2</sup>			
			ELASTORAPID		Component A: 1 bag (25 kg) Component B: tub (6.5 kg)	C2 FTE S2				
		For heated screeds: 50x50; 100x40; 100x50	ELASTORAPID		Component A: 1 bag (25 kg) Component B: tub (6.5 kg)	C2 FTE S2				
		For heated screeds: 100x100; 300x100	KERAQUICK + LATEX PLUS		1 bag (25 kg) + 8.5 kg of LATEX PLUS	C2 FT S2	5 m <sup>2</sup>			
	KERAKOLL	All sizes	H40 REVOLUTION	For gypsum-based or anhydrite surfaces: Primer A Eco	Grey 1 bag (25 kg) from 6 to 7 litres of water	C2F TE	6 m <sup>2</sup>	2 hours	1 day	
			H40 EXTREME	For gypsum-based or anhydrite surfaces: SLC ECO EP 21	White 1 bag (25 kg) from 6 to 7.3 litres of water					
			H40 EXTREME	For gypsum-based or anhydrite surfaces: SLC ECO EP 21	1 bucket (10 kg)	R2	4 m <sup>2</sup>	4 hours	12 hours	
	LATICRETE	All sizes	LATICRETE 335 Rapid Super Flex + LATICRETE 282 Latex Additive	Not necessary, according to manufacturer	1 bag (25 kg) + 6/7 litres of latex	C2 TE F	5 m <sup>2</sup>	6 hours	2 days	
	LITOKOL	50x50; 100x40; 100x50	LITOSTONE K99 + LATEXKOL + water	For gypsum-based surfaces: Primer C	1 bag (25 kg) + 3.5 litres of LATEXKOL + 3.5 litres of water	C2 FE S1	5 m <sup>2</sup>	4 hours	1 day	
					1 bag (25 kg) + 7.5 kg of LATEXKOL	C2 FE S2				
		For heated screeds: all sizes	LITOSTONE K99 + LATEXKOL		1 bag (25 kg) + 7.5 kg of LATEXKOL	C2 FE S2				
	PCI - BASF	All sizes	PCI FLEXMOERTEL S2 RAPID	For gypsum-based surfaces: PCI GISOGRUND	1 bag (20 kg) + 3.8 litres of water	C2 FT S2	8.3 m <sup>2</sup>	5 hours	1 day	
	SAINT-GOBAIN / WEBER	50x50; 100x40; 100x50	WEBER.COL UltraGres Fast	For gypsum-based surfaces: WEBER PRIM PF15. For old ceramic tiles, marble slabs and stone: WEBER.FLOOR 4716 Primer	1 bag (25 kg) + 6/6.3 litres of water	C2 FTE S1	6 m <sup>2</sup>	3 hours	1 day	
1 bag (25 kg) + 6/6.3 litres WEBER L50					C2 FTE S2					
ARDEX	All sizes	ARDEX X 78 S microtec + ARDEX E 90	For gypsum- and anhydrite-based, absorbent or polished surfaces: ARDEX P 51	1 bag (25 kg) + 3 kg of ARDEX E 90 + 7 litres of water	C2 FE S2	6 m <sup>2</sup>	90 min.	6 hours	Installation with substrate troweling of adhesive (trowel with 10 mm tilted teeth or ARDEX Microtec trowel)	

A.5b - Floor installation in interiors/exterior<sup>♦</sup> of KERLITE 3plus and KERLITE 5plus

**Substrate:** hardwood, PVC, rubber, linoleum, metal, resin

At the discretion of P.S.	Supplier	Size of slabs (cm)	Product (*) (***)	Primer, if necessary (*) (***)	Mixing ratio (* *)	Class (*)	Nominal coverage (*)	Set for light foot traffic and ready for grouting times (**)	Ready for use (***)	Installation (*)		
 <p>For situations in which a normal setting adhesive is recommended</p>	MAPEI	All sizes	ULTRABOND ECO PU 2K	Not necessary, according to manufacturer	1 bucket (10 kg)	R2T	2.5 m <sup>2</sup>	12 hours	7 days	Installation with substrate and tile troweling of adhesive		
			KERALASTIC			R2						
			KERALASTIC T			R2T						
	KERAKOLL	All sizes in interiors	H40 NO LIMITS	KERAGRIP ECO	Grey 1 bag (25 kg) from 7.1 to 8.5 litres of water White 1 bag (25 kg) from 7.2 to 9.5 litres of water	C2 TE	6 m <sup>2</sup>	20 hours	3 days			
											All sizes	H40 EXTREME
	LATICRETE	All sizes	LATALASTIK	Not necessary, according to manufacturer	1 bucket of component A (5 kg) 1 bucket of component B (2 kg)	R2T	3 m <sup>2</sup>	1 day	5 days			
	LITOKOL	All sizes	LITOELASTIC	Not necessary, according to manufacturer	1 bucket (10 kg)	R2T	3 m <sup>2</sup>	12 hours	5 days			
	 <p>For situations in which a quick setting adhesive is recommended</p>	PCI - BASF	All sizes	PCI COLLASTIC	Not necessary, according to manufacturer	3 kg bucket (A+B)	R2T	1.5 m <sup>2</sup>	12 hours		1 day	Installation with substrate troweling of adhesive (trowel with 10 mm tilted teeth)
		SAINT-GOBAIN / WEBER	All sizes	WEBER.COL. FIX CR	Not necessary, according to manufacturer	1 bucket (10 kg)	R2T	3 m <sup>2</sup>	12 hours		2 days	Installation with substrate and tile troweling of adhesive
		ARDEX	All sizes	ARDEX X S 28 New Microtec	ARDEX P 82	1 bag (25 kg) + 7.5 to 9 litres of water	C2 FTE S1	6 m <sup>2</sup>	4 hours		1 day	Installation with substrate troweling of adhesive (trowel with 12 mm tilted teeth or ARDEX Microtec trowel)
MAPEI		All sizes	KERAQUICK + LATEX PLUS	Not necessary, according to manufacturer	1 bag (25 kg) + 8.5 kg of LATEX PLUS	C2 FT S2	2.5 m <sup>2</sup>	3 hours	1 day	Installation with substrate and tile troweling of adhesive		
KERAKOLL	All sizes in interiors	H40 REVOLUTION	KERAGRIP ECO	Grey 1 bag (25 kg) from 6 to 7 litres of water	C2 FE	6 m <sup>2</sup>	2 hours	1 day				
				White 1 bag (25 kg) from 6 to 7.3 litres of water								
All sizes	H40 EXTREME	Not necessary, according to manufacturer	1 bucket (10 kg)	R2	4 m <sup>2</sup>	4 hours	12 hours					
LATICRETE	All sizes	LATALASTIK	Not necessary, according to manufacturer	1 bucket of component A (5 kg) 1 bucket of component B (2 kg)	R2T	3 m <sup>2</sup>	1 day	5 days				
LITOKOL	All sizes	LITOELASTIC	Not necessary, according to manufacturer	1 bucket (10 kg)	R2T	3 m <sup>2</sup>	12 hours	7 days				
PCI - BASF	All sizes	PCI COLLASTIC	Not necessary, according to manufacturer	3 kg bucket (A+B)	R2T	1.5 m <sup>2</sup>	3 hours	12 hours	Installation with substrate troweling of adhesive (trowel with 10 mm tilted teeth)			
SAINT-GOBAIN / WEBER	All sizes	WEBER.COL. FIX CR	Not necessary, according to manufacturer	1 bucket (10 kg)	R2 T	3 m <sup>2</sup>	12 hours	2 days	Installation with substrate and tile troweling of adhesive			
ARDEX	All sizes	ARDEX X 78 S microtec + ARDEX E 90	ARDEX P 82	1 bag (25 kg) + 3 kg ARDEX E 90 + 7 litres of water	C2 FE S2	6 m <sup>2</sup>	90 min.	6 hours	Installation with substrate troweling of adhesive (trowel with 10 mm tilted teeth or ARDEX Microtec trowel)			

♦ Upon condition that surfaces are sheltered (e.g. loggias, covered balconies, etc.) and made totally impervious. The use of sizes that are not larger than 100x100 cm is recommended.

(\*) Instructions provided directly by manufacturers, who guarantee the information given. For explanations or more details, contact the technical support offices of the product manufacturers (see "9 - Useful contacts").

(\*\*) Instructions provided directly by manufacturers, who guarantee the information given. If a product is offered in both "white" and a "grey" versions, the mixing ratio may vary. For explanations or more details, contact the technical support offices of the product manufacturers (see "9 - Useful contacts").

(\*\*\*) Ratings provided directly by manufacturers, who guarantee the information given, are based on laboratory tests performed at 23° C and with a relative humidity of 50%. In the event of use in different situations or for explanations or more details, contact the technical support offices of the product manufacturers (see "9 - Useful contacts").

(\*\*\*\*) Product names shown may vary according to destination countries in relation to the commercial assessment of the manufacturer.







**IMPORTANT**

The information and directions provided in this manual are to be considered valid until an update is published. The updated document replaces all previous publications. It is possible to check for updates on the company web site or contact the company's technical support office. The company reserves the right to modify the contents and appearance of this manual, should this be deemed necessary.

Follow us on:



Quality management system



Environmental management systems of production sites



Stabilimento di FIORANO (MO)

Panariagroup Industrie Ceramiche S.p.A. is a member of the U.S. Green Building Council and Green Building Council Italia



**kerlite**<sup>®</sup>  
COTTO D'ESTE PROJECT

**COTTOD'ESTE**<sup>®</sup> | LA  
Nuove Superfici | BELLEZZA  
IN  
CERAMICA

Via Emilia Romagna, 31 41049 Sassuolo (MO) Italy  
+39 0536 814 911 fax +39 0536 814 918  
cottodeste.it - info@cottodeste.it - kerlite.it  
PANARIAGROUP INDUSTRIE CERAMICHE S.p.A.